



TEC-EQUIPMENT



Aggregate



Cement

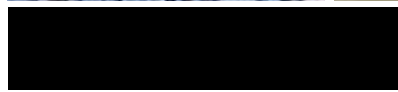

Materials Testing Equipment



Concrete



Asphalt



Soil

Catalog 3rd

About Us

Tec Equipment Limited Partnership have established since 1989 in Bangkok, Thailand. We are specialized in Testing Equipment. Our main products are used for test many material such as Aggregate, Asphalt, Soil , Cement and Concrete. Tec Equipment is known for high quality, reasonable price and best after sale service. Our products are export to Laos, Myanmar and Cambodia.

Manufacturer Leading manufacturer and supplier



Service Repair and Calibration









Training





index

Aggregate		page 4
Asphalt		page 12
Soil		page 16
Cement		page 24
Concrete		page 32
General		page 48
Code Index	T-10120..... T-10446..... T-10228..... T-10775..... T-10776..... T-11005.....	page 58

Catalog Guide

For a quick response, please always state product codes in your request.

Example

Product name

Model no.

Sieve Shaker Square: T-1000

Description

Tec Equipment Simple sieve shaker provides a compact design and simple operation. The shaker comes with an powerfull electric motor and rugged steel ready for routine test.

- It can be used with 8" dia sieves.
- It can handle up to 7 Layers
- Power: 220V 50Hz

Sieves are not included.

Model no.

Product name

Model	Description
T-1900.1	measuring cylinder
T-1900R	rubber pipes
T-1900C	Clips
T-1900S	stirring rod



aggregate

Aggregate Section:

Product	page	Product	page
Sieve Shaker Square.....	5	Specific Gravity Set.....	7
Sieve Shaker Circular.....	5	-Density Basket.....	7
Aggregate Shaker Seven Trays.....	5	-Specific Gravity Tank.....	7
Sample Splitter, Large capacity.....	6	Absorption of Fine Aggregate	
Sample Splitter, Riffle.....	6	-Cone & Tamper.....	7
Elongation Index.....	6	Aggregate crushing value apparatus.....	8
Flaskiness Index.....	6	Aggregate impact value apparatus.....	8
Los Angeles Abrasion Machine.....	7	Siphon can apparatus.....	8
Storage room sounds.....	7	USA Standard Sieve, Humboldt.....	9-11

Sieve Shaker Series



T-1000



T-1002



T-1003

Sieve Shaker Square: T-1000

Tec Equipment Simple sieve shaker provides a compact design and simple operation. The shaker comes with an powerful electric motor and rugged steel ready for routine test.

- It can be used with 8" dia sieves.
 - It can handle up to 7 Layers
 - Power: 220V 50Hz
- Sieves are not included.

Sieve Shaker Circular: T-1002

Sieve shaker Circular is a high performance unit with a good construction. Rapid vertical action assist in the continuous clearing of sieves. The best performance and power full motor and easy to adjust vibration.

- It can be used with 8" to 12" dia sieves.
 - It can handle up to 8 Layers
 - Built-in Timer.
 - Power: 220V 50Hz
- Sieves are not included.

Aggregate Shaker Seven Trays: T-1003

Vibration is mechanically smooth , stable and simple operation. Secured for operation by two hand clamp levers. When levers are released, Trays are individually removable for emptying ,cleaning and weighing. The screens are durable also useful for size separations. Capacity depend on test materials ,but may up to 25kg per test. Includes trays and screens.

- Slots for 7 trays.
- Timer built-in
- Power: 220V 50Hz

Screen Shakers

Model	Size
T-1003S2	2" (50 mm.)
T-1003S1.5	1.5" (37.5 mm.)
T-1003S1	1" (25 mm.)
T-1003S.750	3/4" (19 mm.)
T-1003S.500	1/2" (12.5 mm.)
T-1003S.375	3/8" (9.5 mm.)
T-1003S.4	no.4 (4.75 mm.)
T-1003P	pan.

Sample Splitter Series



T-1200L



T-1200R.1



T-1200P

Elongation Index



T-1300

Flaskiness Index



T-1350

Sample Splitter, Large capacity: T-1200L

The Sample Splitter is designed and developed to meet the requirements for large volume. Easy to pour the material. It handles any material from size up to 4" (102mm.) of material. It is convenient by handling and pull the lever to divide the samples into the tray. The chute can be adjustable by flipping the bar. Includes trays.

- The lever hopper up to 1 cu.ft. (0.028 m³).
- Chute bar opening: 1/2", 1", 1-1/2", 2", 3", 4".

Elongation Index: T-1300

For determining elongation index. Measuring the length of aggregates. The Elongation index comes with six openings and mark between pair of metal pins.

Flaskiness Index: T-1350

For determining Flaskiness Index of coarse aggregate. It has a different mark standard length, widths and seven different openings.

Sample Splitter, Riffle

The Sample splitter riffle type is used for dividing materials such as aggregates, sand, gravel or similar material. The design is for simple and light weight material. The materials poured into the hopper are divided into two equal portion and in opposite directions into two separate pans provided.

Consist of :Includes 3 pans.

Model	Chutes
T-1200R.375	3/8"
T-1200R.500	1/2"
T-1200R.750	3/4"
T-1200R.1	1"
T-1200R.2	2"

Pans for Sample Splitter, Riffle: T-1200P

Pans for Sample Splitter, Riffle. Materials Pan for Sample

Los Angeles Abrasion



MH-II



T-1400.12



T-1400P



T-1401

Los Angeles Abrasion Machine: MH-II

Determines test for resistance to abrasion in crushed rocks, slags, crushed and uncrushed gravel by using Los Angeles testing method.

Features welded structural steel frame and fabricated 1/2" (913mm) thick, abrasion resistant steel drum, bolted to the drum and a balanced drum assembly for easy rotation by hand. The electronic control with digital display and automatic stop at end of cycle.

Includes a removeable pan and 12 abrasion charges.

- 12 abrasion charges.: T-1400.12
- Removeable pan.: T-1400P

Storage room sounds: T-1401

The cabinet manufactured from sheet steel line internally with sound proof material to reduce noise. This sound proof cabinet designed to use with Los Angeles Machine

- 12 abrasion charges.
- Removeable pan.

Aluminum Plate: T-1604

Aluminum Plate with circle guide lines on top.

Absorption of Fine Aggregate



T-1601



T-1602



T-1604



T-1603

Specific Gravity Set



T-1500



T-1501



T-1502

Specific Gravity Frame: T-1500

The specific gravity made of welded steel frame with chain, locked and handle to raise the bench up. Order Density Basket, Tank and Balance scale separately.

Density Basket: T-1501

Stainless steel wire mesh.

Specific Gravity Tank: T-1502

Simple design tank with handle easy to lift.

Digital Balance

For more detail see digital balance page.

Absorption of Fine Aggregate Cone: T-1601

Determines test of absorption of fine aggregate.

- Mold size : Top 40mm.dia. ,Bottom 90mm.dia. Height 75mm. .

Tamper: T-1602

Determines test of absorption of fine aggregate.

- Flat circular tamping face 25 mm. dia.

Glass Plate: T-1603

Glass plate 300mm.x 300mm. x 10mm.

Aggregate crushing value

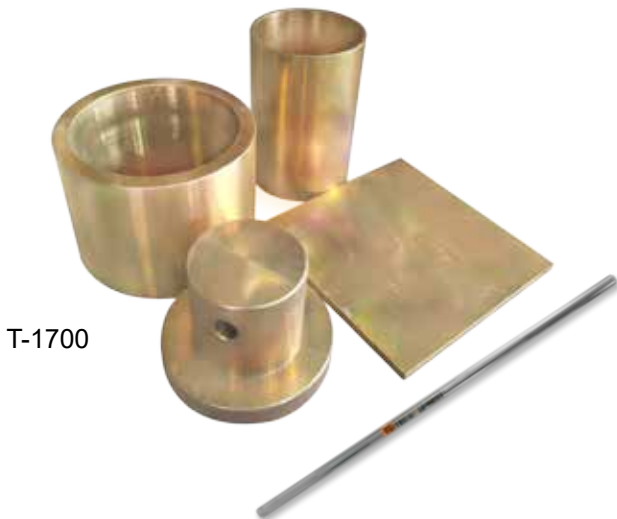

T-1700

Aggregate impact value



T-1800

Siphon can apparatus



T-1900.1

T-1900C

T-1900S

T-1900R

T-1900

Aggregate Crushing Value Apparatus: T-1700

STANDARD: comparable to BS 812:110

Used to determine the crushing value for the aggregate particles.

- Contains the standard Aggregate Crushing Value pieces.
- The cylinder supplied with the set is made of a heavy duty steel to resist the impacts during the test.
- Includes a plunger, tamping rod and a base plate. The complete assembly is cadmium plated for corrosion protection.

Specifications:

Model	aggregate passing	cylinder dia.	measure
T-AC075	9.5mm	75mm	57mm. x 90mm.
T-AC150	12.7mm retaining on 9.5mm	150mm	115mm. x 180mm.

Aggregate Impact Value Apparatus: T-1800

STANDARDS: BS 812 / NF P18-574

Used to determine the impact value of aggregates and select them for a given application. The machine has a trip-action hammer release, blow counter device and a built-in operator safety device.

Manufactured in heavy duty form with hardened steel surfaces for minimum wear.

The complete assembly is cadmium plated for corrosion protection.

Siphon Can Apparatus: T-1900

STANDARD: BS 812 - part 2

Used to determine the moisture content at known conditions. Supplied complete with measuring cylinder, rubber pipes fitted with screw clips, stirring rod.

Accessories

Model	Description
T-1900.1	measuring cylinder
T-1900R	rubber pipes
T-1900C	Clips
T-1900S	stirring rod

U.S.A. Standard Sieve Series

U.S.A. Standard Sieve Series

Looking for sieves? Humboldt stocks an extensive offering of sieves for use in all types of sieve testing applications, from sampling and classification of soils, aggregates and other powdered and granular materials to specific ASTM standard tests. Humboldt carries an extensive inventory of sieves in all popular sizes and mesh/frame material configurations.

We try to maintain a complete stock of 8" and 12" sieves in both full and half heights for quick turnaround, as well as keeping a large inventory of other sieve sizes and frame and mesh configurations. Our sieves are of the highest quality to ensure consistent fit, accurate specifications and durable construction. All our sieves comply with ASTM E11 and AASHTO M92; and, are given individual serial numbers for traceability. Certified sieves are also available as an option, please inquire.

Humboldt sieves are available with brass frame and mesh, brass frame with stainless steel mesh or stainless frame and mesh. Brass sieves are cost efficient while stainless sieves tend to last longer and have sag resistant mesh. Sieve frames are seamless spun brass or stainless steel with rigid rolled edges and extended bottoms (skirts) to ensure a good fit between frames, pans and separators of the same diameter— ensuring that your set of sieves stacks properly.

All sieves include a permanently attached metal plate that includes the sieve number, micron size and the nominal opening in millimeters and inches. Sieve covers, bottom pans and separator pans are also in stock and ready for shipment.

Alternative Number	Nominal Opening	Standard (mm)
4"	4.000	100mm
3.5"	3.500	90mm
3"	3.000	75mm
2.5"	2.500	63mm
2.12"	2.120	53mm
2"	2.000	50mm
1.75"	1.750	45mm
1.5"	1.500	37.5mm
1.25"	1.250	31.5mm
1.06"	1.060	26.5mm
1"	1.000	25.0mm
.875"	0.875	22.4mm
.75"	0.750	19.0mm
.625"	0.625	16.0mm
.530"	0.530	13.2mm
.500"	0.500	12.5mm
.434"	0.434	11.2mm
.375"	0.375	9.5mm
.312"	0.312	8.0mm
.265"	0.265	6.7mm
.25"	0.250	6.3mm
.125"	0.125	3.17mm
No. 3-1/2	0.223	5.6mm
No. 4	0.187	4.75mm
No. 5	0.157	4.00mm
No. 6	0.131	3.35mm
No. 7	0.110	2.80mm
No. 8	0.094	2.36mm
No. 10	0.078	2.00mm
No. 12	0.066	1.70mm
No. 14	0.055	1.40mm
No. 16	0.046	1.18mm
No. 18	0.039	1.00mm
No. 20	0.033	850µm
No. 25	0.027	710µm
No. 30	0.023	600µm
No. 35	0.019	50µm
No. 40	0.016	425µm
No. 45	0.013	355µm
No. 50	0.011	300µm
No. 60	0.009	250µm
No. 70	0.008	212µm
No. 80	0.007	180µm
No. 100	0.005	150µm
No. 120	0.0049	125µm
No. 140	0.0041	106µm
No. 170	0.0035	90µm
No. 200	0.0029	75µm
No. 230	0.0024	62µm
No. 270	0.0020	53µm
No. 325	0.0017	45µm
No. 400	0.0014	38µm
No. 450	0.0012	32µm
No. 500	0.0009	25µm
No. 635	0.0007	20µm
No. 850	0.0004	10µm
No. 1000	0.00008	2µm



Sieve Covers with Ring Handle

Description Dia x Depth	Brass	Stainless
3"	H-3913BC	H-3913SC
4"	H-3914BC	—
5"	H-3915BC	—
6"	H-3916BC	—
8"	H-3930BC	H-3930SC
10"	H-3919BC	—
12"	H-3912BC	H-3912SC

Sieve Bottom Pans

Description Dia x Depth	Brass	Stainless
3" x .625"	H-3913HP	H-3913SS
3" x 1"	H-3913P	—
4" x 1.5"	H-3914P	—
5" x 1"	H-3915P	—
6" x 1.625"	H-3916P	—
8" x 1"	H-3960P	H-3960SS
8" x 2"	H-3920P	H-3950SS
10" x 2"	H-3919P	—
12" x 1"	H-3932P	H-3932PSS
12" x 2"	H-3922P	—
12" x 3"	H-3912P	H-3912SS

USA Standard
ASTM Test Sieves



Sieve Size	Brass Frame Stainless Mesh		Stainless Frame Stainless Mesh	
	Full Height 2" (50mm)	Half Height 1" (25mm)	Full Height 2" (50mm)	Half Height 1" (25mm)
4" (100mm)	H-3920CS4.000	H-3910CS4.000	H-3920CSS4.000	H-3910CSS4.000
3-1/2" (90mm)	H-3920CS3.500	H-3910CS3.500	H-3920CSS3.500	H-3910CSS3.500
3" (75mm)	H-3920CS3.000	H-3910CS3.000	H-3920CSS3.000	H-3910CSS3.000
2-1/2" (63mm)	H-3920CS2.500	H-3910CS2.500	H-3920CSS2.500	H-3910CSS2.500
2.12" (53mm)	H-3920CS2.120	H-3910CS2.120	H-3920CSS2.120	H-3910CSS2.120
2" (50mm)	H-3920CS2.000	H-3910CS2.000	H-3920CSS2.000	H-3910CSS2.000
1-3/4" (45mm)	H-3920CS1.750	H-3910CS1.750	H-3920CSS1.750	H-3910CSS1.750
1-1/2" (37.5mm)	H-3920CS1.500	H-3910CS1.500	H-3920CSS1.500	H-3910CSS1.500
1-1/4" (31.5mm)	H-3920CS1.250	H-3910CS1.250	H-3920CSS1.250	H-3910CSS1.250
1.06" (26.5mm)	H-3920CS1.060	H-3910CS1.060	H-3920CSS1.060	H-3910CSS1.060
1" (25.0mm)	H-3920CS1.000	H-3910CS1.000	H-3920CSS1.000	H-3910CSS1.000
7/8" (22.4mm)	H-3920CS.875	H-3910CS.875	H-3920CSS.875	H-3910CSS.875
3/4" (19.0mm)	H-3920CS.750	H-3910CS.750	H-3920CSS.750	H-3910CSS.750
5/8" (16.0mm)	H-3920CS.625	H-3910CS.625	H-3920CSS.625	H-3910CSS.625
0.530" (13.2mm)	H-3920CS.530	H-3910CS.530	H-3920CSS.530	H-3910CSS.530
1/2" (12.5mm)	H-3920CS.500	H-3910CS.500	H-3920CSS.500	H-3910CSS.500
7/16" (11.2mm)	H-3920CS.438	H-3910CS.438	H-3920CSS.438	H-3910CSS.438
3/8" (9.5mm)	H-3920CS.375	H-3910CS.375	H-3920CSS.375	H-3910CSS.375
5/16" (8.0mm)	H-3920CS.312	H-3910CS.312	H-3920CSS.312	H-3910CSS.312
0.265" (6.7mm)	H-3920CS.265	H-3910CS.265	H-3920CSS.265	H-3910CSS.265
1/4" (6.3mm)	H-3920CS.250	H-3910CS.250	H-3920CSS.250	H-3910CSS.250
1/8" (3.17mm)	H-3920CS.125	H-3910CS.125	H-3920CSS.125	H-3910CSS.125

8"

203mm

No. 3-1/2 (5.6mm)	H-3920FS3-1/2	H-3910FS3-1/2	H-3920FSS3-1/2	H-3910FSS3-1/2
No. 4 (4.75mm)	H-3920FS4	H-3910FS4	H-3920FSS4	H-3910FSS4
No. 5 (4.0mm)	H-3920FS5	H-3910FS5	H-3920FSS5	H-3910FSS5
No. 6 (3.35mm)	H-3920FS6	H-3910FS6	H-3920FSS6	H-3910FSS6
No. 7 (2.80mm)	H-3920FS7	H-3910FS7	H-3920FSS7	H-3910FSS7
No. 8 (2.36mm)	H-3920FS8	H-3910FS8	H-3920FSS8	H-3910FSS8
No. 10 (2.00mm)	H-3920FS10	H-3910FS10	H-3920FSS10	H-3910FSS10
No. 12 (1.70mm)	H-3920FS12	H-3910FS12	H-3920FSS12	H-3910FSS12
No. 14 (1.40mm)	H-3920FS14	H-3910FS14	H-3920FSS14	H-3910FSS14
No. 16 (1.18mm)	H-3920FS16	H-3910FS16	H-3920FSS16	H-3910FSS16
No. 18 (1.0mm)	H-3920FS18	H-3910FS18	H-3920FSS18	H-3910FSS18
No. 20 (850µm)	H-3920FS20	H-3910FS20	H-3920FSS20	H-3910FSS20
No. 25 (710µm)	H-3920FS25	H-3910FS25	H-3920FSS25	H-3910FSS25
No. 30 (600µm)	H-3920FS30	H-3910FS30	H-3920FSS30	H-3910FSS30
No. 35 (500µm)	H-3920FS35	H-3910FS35	H-3920FSS35	H-3910FSS35
No. 40 (425µm)	H-3920FS40	H-3910FS40	H-3920FSS40	H-3910FSS40
No. 45 (355µm)	H-3920FS45	H-3910FS45	H-3920FSS45	H-3910FSS45
No. 50 (300µm)	H-3920FS50	H-3910FS50	H-3920FSS50	H-3910FSS50
No. 60 (250µm)	H-3920FS60	H-3910FS60	H-3920FSS60	H-3910FSS60
No. 70 (212µm)	H-3920FS70	H-3910FS70	H-3920FSS70	H-3910FSS70
No. 80 (180µm)	H-3920FS80	H-3910FS80	H-3920FSS80	H-3910FSS80
No. 100 (150µm)	H-3920FS100	H-3910FS100	H-3920FSS100	H-3910FSS100
No. 120 (125µm)	H-3920FS120	H-3910FS120	H-3920FSS120	H-3910FSS120
No. 140 (106µm)	H-3920FS140	H-3910FS140	H-3920FSS140	H-3910FSS140
No. 170 (90µm)	H-3920FS170	H-3910FS170	H-3920FSS170	H-3910FSS170
No. 200 (75µm)	H-3920FS200	H-3910FS200	H-3920FSS200	H-3910FSS200
No. 230 (63µm)	H-3920FS230	H-3910FS230	H-3920FSS230	H-3910FSS230
No. 270 (53µm)	H-3920FS270	H-3910FS270	H-3920FSS270	H-3910FSS270
No. 325 (45µm)	H-3920FS325	H-3910FS325	H-3920FSS325	H-3910FSS325
No. 400 (38µm)	H-3920FS400	H-3910FS400	H-3920FSS400	H-3910FSS400
No. 450 (32µm)	H-3920FS450	H-3910FS450	H-3920FSS450	H-3910FSS450
No. 500 (25µm)	H-3920FS500	H-3910FS500	H-3920FSS500	H-3910FSS500
No. 635 (20µm)	H-3920FS635	H-3910FS635	H-3920FSS635	H-3910FSS635
No. 850 (10µm)	H-3920FS850	H-3910FS850	-	-
No. 1000 (2µm)	H-3920FS1000	H-3910FS1000	-	-



USA Standard
ASTM Test Sieves

Sieve Size	Brass Frame Stainless Mesh			Stainless Frame Stainless Mesh	
	Full Height 3" (75mm)	Inter. Height 2" (50mm)	Half Height 1.625" (41mm)	Full Height 3" (75mm)	Half Height 1.625" (41mm)
4" (100mm)	H-3912CS4.000	H-3922CS4.000	H-3932CS4.000	H-3912CSS4.000	H-3932CSS4.000
3-1/2" (90mm)	H-3912CS3.500	H-3922CS3.500	H-3932CS3.500	H-3912CSS3.500	H-3932CSS3.500
3" (75mm)	H-3912CS3.000	H-3922CS3.000	H-3932CS3.000	H-3912CSS3.000	H-3932CSS3.000
2-1/2" (63mm)	H-3912CS2.500	H-3922CS2.500	H-3932CS2.500	H-3912CSS2.500	H-3932CSS2.500
2.12" (53mm)	H-3912CS2.120	H-3922CS2.120	H-3932CS2.120	H-3912CSS2.120	H-3932CSS2.120
2" (50mm)	H-3912CS2.000	H-3922CS2.000	H-3932CS2.000	H-3912CSS2.000	H-3932CSS2.000
1-3/4" (45mm)	H-3912CS1.750	H-3922CS1.750	H-3932CS1.750	H-3912CSS1.750	H-3932CSS1.750
1-1/2" (37.5mm)	H-3912CS1.500	H-3922CS1.500	H-3932CS1.500	H-3912CSS1.500	H-3932CSS1.500
1-1/4" (31.5mm)	H-3912CS1.250	H-3922CS1.250	H-3932CS1.250	H-3912CSS1.250	H-3932CSS1.250
1.06" (26.5mm)	H-3912CS1.060	H-3922CS1.060	H-3932CS1.060	H-3912CSS1.060	H-3932CSS1.060
1" (25.0mm)	H-3912CS1.000	H-3922CS1.000	H-3932CS1.000	H-3912CSS1.000	H-3932CSS1.000
7/8" (22.4mm)	H-3912CS.875	H-3922CS.875	H-3932CS.875	H-3912CSS.875	H-3932CSS.875
3/4" (19.0mm)	H-3912CS.750	H-3922CS.750	H-3932CS.750	H-3912CSS.750	H-3932CSS.750
5/8" (16.0mm)	H-3912CS.625	H-3922CS.625	H-3932CS.625	H-3912CSS.625	H-3932CSS.625
0.530" (13.2mm)	H-3912CS.530	H-3922CS.530	H-3932CS.530	H-3912CSS.530	H-3932CSS.530
1/2" (12.5mm)	H-3912CS.500	H-3922CS.500	H-3932CS.500	H-3912CSS.500	H-3932CSS.500
7/16" (11.2mm)	H-3912CS.438	H-3922CS.438	H-3932CS.438	H-3912CSS.438	H-3932CSS.438
3/8" (9.5mm)	H-3912CS.375	H-3922CS.375	H-3932CS.375	H-3912CSS.375	H-3932CSS.375
5/16" (8.0mm)	H-3912CS.312	H-3922CS.312	H-3932CS.312	H-3912CSS.312	H-3932CSS.312
0.265" (6.7mm)	H-3912CS.265	H-3922CS.265	H-3932CS.265	H-3912CSS.265	H-3932CSS.265
1/4" (6.3mm)	H-3912CS.250	H-3922CS.250	H-3932CS.250	H-3912CSS.250	H-3932CSS.250
1/8" (3.17mm)	H-3912CS.125	H-3922CS.125	H-3932CS.125	-	H-3932CSS.125



12"
305mm

No. 3-1/2 (5.6mm)	H-3912FSS3-1/2	H-3922FSS3-1/2	H-3932FSS3-1/2	H-3912FSS3-1/2	H-3932FSS3-1/2
No. 4 (4.75mm)	H-3912FSS4	H-3922FSS4	H-3932FSS4	H-3912FSS4	H-3932FSS4
No. 5 (4.0mm)	H-3912FSS5	H-3922FSS5	H-3932FSS5	H-3912FSS5	H-3932FSS5
No. 6 (3.35mm)	H-3912FSS6	H-3922FSS6	H-3932FSS6	H-3912FSS6	H-3932FSS6
No. 7 (2.80mm)	H-3912FSS7	H-3922FSS7	H-3932FSS7	H-3912FSS7	H-3932FSS7
No. 8 (2.36mm)	H-3912FSS8	H-3922FSS8	H-3932FSS8	H-3912FSS8	H-3932FSS8
No. 10 (2.00mm)	H-3912FSS10	H-3922FSS10	H-3932FSS10	H-3912FSS10	H-3932FSS10
No. 12 (1.70mm)	H-3912FSS12	H-3922FSS12	H-3932FSS12	H-3912FSS12	H-3932FSS12
No. 14 (1.40mm)	H-3912FSS14	H-3922FSS14	H-3932FSS14	H-3912FSS14	H-3932FSS14
No. 16 (1.18mm)	H-3912FSS16	H-3922FSS16	H-3932FSS16	H-3912FSS16	H-3932FSS16
No. 18 (1.0mm)	H-3912FSS18	H-3922FSS18	H-3932FSS18	H-3912FSS18	H-3932FSS18
No. 20 (850µm)	H-3912FSS20	H-3922FSS20	H-3932FSS20	H-3912FSS20	H-3932FSS20
No. 25 (710µm)	H-3912FSS25	H-3922FSS25	H-3932FSS25	H-3912FSS25	H-3932FSS25
No. 30 (600µm)	H-3912FSS30	H-3922FSS30	H-3932FSS30	H-3912FSS30	H-3932FSS30
No. 35 (500µm)	H-3912FSS35	H-3922FSS35	H-3932FSS35	H-3912FSS35	H-3932FSS35
No. 40 (425µm)	H-3912FSS40	H-3922FSS40	H-3932FSS40	H-3912FSS40	H-3932FSS40
No. 45 (355µm)	H-3912FSS45	H-3922FSS45	H-3932FSS45	H-3912FSS45	H-3932FSS45
No. 50 (300µm)	H-3912FSS50	H-3922FSS50	H-3932FSS50	H-3912FSS50	H-3932FSS50
No. 60 (250µm)	H-3912FSS60	H-3922FSS60	H-3932FSS60	H-3912FSS60	H-3932FSS60
No. 70 (212µm)	H-3912FSS70	H-3922FSS70	H-3932FSS70	H-3912FSS70	H-3932FSS70
No. 80 (180µm)	H-3912FSS80	H-3922FSS80	H-3932FSS80	H-3912FSS80	H-3932FSS80
No. 100 (150µm)	H-3912FSS100	H-3922FSS100	H-3932FSS100	H-3912FSS100	H-3932FSS100
No. 120 (125µm)	H-3912FSS120	H-3922FSS120	H-3932FSS120	H-3912FSS120	H-3932FSS120
No. 140 (106µm)	H-3912FSS140	H-3922FSS140	H-3932FSS140	H-3912FSS140	H-3932FSS140
No. 170 (90µm)	H-3912FSS170	H-3922FSS170	H-3932FSS170	H-3912FSS170	H-3932FSS170
No. 200 (75µm)	H-3912FSS200	H-3922FSS200	H-3932FSS200	H-3912FSS200	H-3932FSS200
No. 230 (63µm)	H-3912FSS230	H-3922FSS230	H-3932FSS230	H-3912FSS230	H-3932FSS230
No. 270 (53µm)	H-3912FSS270	H-3922FSS270	H-3932FSS270	H-3912FSS270	H-3932FSS270
No. 325 (45µm)	H-3912FSS325	H-3922FSS325	H-3932FSS325	H-3912FSS325	H-3932FSS325
No. 400 (38µm)	H-3912FSS400	H-3922FSS400	H-3932FSS400	H-3912FSS400	H-3932FSS400
No. 450 (32µm)	H-3912FSS450	H-3922FSS450	H-3932FSS450	H-3912FSS450	H-3932FSS450
No. 500 (25µm)	H-3912FSS500	H-3922FSS500	H-3932FSS500	H-3912FSS500	H-3932FSS500
No. 635 (20µm)	H-3912FSS635	H-3922FSS635	H-3932FSS635	H-3912FSS635	H-3932FSS635
No. 850 (10µm)	H-3912FSS850	H-3922FSS850	H-3932FSS850	-	-
No. 1000 (2µm)	H-3912FSS1000	H-3922FSS1000	H-3932FSS1000	-	-





asphalt

Asphalt Section:

Product	page	Product	page
Marshall test set		Electric Centrifuge Extractor.....	14
- Marshall Compression Machine	13	Centrifuge Extractor.....	14
- Stability Mold (Breaking head).....	13	Water Bath.....	14
- Proving Ring.....	13	Hot Plate.....	14
- Piston.....	13	Strength Index Mold.....	14
- Dial Flowmeter Kit.....	13	Ring and Ball Softening Point.....	14
- Compaction Pedestal.....	13	Ductilometer.....	15
- Hammer guide.....	13	Cohesion Tester.....	15
- Stability Compaction Hammer.....	13	Wet track abrasion tester.....	15
- Stability Compaction Mold.....	13	Mixer.....	15
- Mold Holder.....	13		
- Sample Ejector.....	13		

Marshall test set



Marshall Compression Machine: T-2000
Simple to operate and high performance. The motor has a one speed with reversing switch and one button operation.
• Power: 220V , 50Hz.
Accessories order separately.

Stability Mold (Breaking head): T-2010
The Stability Mold consist of two plate of curvature for 4" sample. Two guide rods free sliding fit on the guide rods.

Proving Ring: T-16006
Made of elastic steel ring with dial indicator.
For more detail see in Proving Ring page.

Piston: T-2020
Steel coated for rust resistance.
4" High, 2" dia. surface.

Dial Flowmeter Kit , H-1344
ASTM D6927
Used to measure flow during Marshall testing. Consists of a special dial indicator with a maximum position brake assembly and a guide sleeve, which fits over either guide rod of Stability Mold. H-1344M has a range of 25mm. with 0.25mm. divisions.

Compaction Pedestal: T-2100
A classic hand compaction of 4" marshall samples. Consist of wooden base with steel plate coated for rust resistance on top. Includes Hammer guide.
• Steel Plate 12"x12"x1" thick.

Hammer Guide: T-2110
Made of Steel coated for rust resistance.

Stability Compaction Hammer: T-2200
Compaction Hammer used for compact asphalt mixture in Marshall Compaction Mold.
• 10 lbs Weight. 18" drop height.

Stability Compaction Mold: T-2250
Consist of:
• Base plate.
• Mold cylinder, 4" dia. 3" height.
• Extension Collar.

Mold Holder: T-2300
Holding and keeps the Marshall Compaciton Mold rescuely positioned during testing.

Sample Ejector: T-2350
Designed for eject sample from 4" dia. Marshall Compaction Mold. Hand operated hydraulic jack.

Electric Centrifuge Extractor

SLF-400.F

SLF-400

Centrifuge Series Hand Operate

T-3100F

T-3100

Electric Centrifuge Extractor: SLF-400

Used to determination of bitumen percentage in bituminous mixtures. Stable operation with less vibration & noise
Variable speed control system Brake control for fast stop

- Speed 0 - 3600 r.p.m. (Adjustable)
- Capacity: 3000 gram.
- Power: 220V. 50Hz 1ph.

Filter Paper for: SLF-400.F

For Centrifuge extractor

- Capacity:
- Dimension: Inner dia.: 15.3cm approx
Out dia.: 32.3cm approx

Centrifuge Extractor: T-3100

To determine the quantitative of bitumen in bituminous paving mixtures. Cover cast aluminium removable.
Hand operate.

- Capacity: 1500 gram.

Filter Paper: T-3100F

For Centrifuge extractor

- Capacity:
- Dimension: Inner dia.: 4.5cm approx
Out dia. : 25.2cm approx

Water Bath

HHW21.600AI

**Digital Hot Plate**

SH-8C

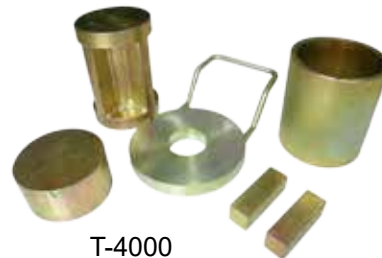
Strength Index Mold

T-4000

Ring and Ball softening point

CXS-2806

Strength Index Mold: T-4000

For testing asphalt stability and mix design.

Consist of:

- Mold 4"x5" height.
- Bottom Plunger 3-7/8" x 2" approx
- Top Plunger 3-7/8" x 5-5/16" height approx.
- Two Temporary supports.

Water Bath: HHW21.600AI

It is used in laboratory constant temperature culturing.
Simple function key for temperature setting.

- Temperature Range From Ambient to +99°C
- Capacity 36 litres approx.
- Power: 220V 50Hz.

Digital Hot Plate: SH-8C

Economy simple hot plate, repeatable temperature are achieved with a special function.

- Range of time: 0-9999 minutes or hours
- Top plate 350mm x 600mm. approx.
- Range of temperature: 0-300
- Power: 220V 50Hz

Ring and Ball Softening Point Apparatus:

CXS-2806

The softness of bitumen depends, amongst other factors, on the temperature of the substance, where, as the temperature is raised, the softness of the bitumen increases.

The unit consists of a pyrex beaker, brass frame, two tapered rings, two ball centering guides and two balls.

- Temperature range 5-125C.
- Test time 0-99 mins

Ductilometer



SY-1.5C

Cohesion tester



T-4100

Ductilometer: SY-1.5C

Used to determine the bituminous ductility, that is to say, the distance to which a briquette of molten bitumen can be extended under controlled conditions, before its breaking. The Ductilometer basically consists of a moving carriage travelling along guide ways. The carriage is driven by an electrical motor, inside a large tank which is fitted with digital thermostat, immersion electric heater, cooling coil for cold water circulation and pump unit. This model works in an automatic way at a speed of 50 mm/min. and its max. stroke is 1500 mm. The tank and the external frame are all made from stainless steel with fibreglass insulation.

Water bath temperature is maintained constant at 25°C ± 0,5°C. by a digital thermoregulator. The unit is equipped of a dual safety thermostat to prevent accidental over-temperatures.

Max. traction force: 300 N, accuracy: ± 0,1 N

The ductilometer can accept up to 3 specimens simultaneously. Supplied complete "except" for the briquette mould and base plate that must be ordered separately (see accessories).

Power: 220V 1 ph 50 Hz

Cohesion Tester (Dead weight): T-4100

The instrument is used for cohesion tests on the mix and to determine the proper consistency or mix design for a slurry seal mixture. The sample will be tested with 28psi (193kpa) approx. Reading by hand Torque tester.

Supplied complete:

Cohesion tester ,Torque wrench and Block.

Wet Track Abrasion Tester

T-4200



Mixer

T-11005.1



T-11005.2



T-11005



Wet track abrasion tester: T-4200

The wet track abrasion of slurry tester for determining the resistance to abrasion of slurry seal mixed ASTM D3910 Specification:

The planetary type mechanical stirrer includes:

- 1 spun stainless steel pan 13" dia. approx.
- 50 Asphalt felt pad 11-1/4" dia.(30lbs)
- 2 Acrylic bold 11" I.D.
- 30 Abrasion hose (300psi)
- 2 Hard wood size 2"x2"x8-1/4"
- 12 Alum.plate 11-1.4"dia.

Mixer

Bench model unit for mixing cement paste and mortars. Includes Bowl and Beater.

Power: 220V, 50Hz.

Capacity	Model.
5 litres	T-11005
10 litres	T-11010
20 litres	T-11020

Beater: T-11005.2

The beater made of stainless steel for mixing heavy materials

Bowl: T-11005.1

Stainless steel 4.73L.



soil

Soil Section:

Product	page	Product	page
Field density		- Circular Surcharge Weight.....	18
- Sand Cone.....	17	- Slot Surcharge Weight.....	18
- Base Plate.....	17	- Filter Paper.....	18
- Plastic Jar.....	17	- Modified Compaction Hammer.....	18
- Stainless Steel Jar.....	17	- Spacer Dish.....	18
- Density Sand.....	17	- Tripod.....	18
Plastic Limit Test Set		- Swell Plate.....	18
- Glass Plate 300mm x 300mm x10mm.....	17	- Straight Edge.....	18
- Mixing Dish.....	17	Compaction Testing.....	19
- Spatula 4".....	17	- Modified Compaction Hammer.....	19
- Graduated Cylinder.....	17	- Standard Compaction Hammer.....	19
- Aluminum Can.....	17	- Sample Ejector.....	19
Atterberg limit set.....	17	- Straight Edge.....	19
- Atterberg Device.....	17	- Modified Compaction Mold.....	19
- Grooving Tool- ASTM standards.....	17	- Standard Compaction Mold.....	19
- Grooving Tool- AASHTO standards.....	17	Sand Equivalent Testing.....	20
- Mixing Dish.....	17	Sand Equivalent Test Shaker.....	20
- Spatula 4".....	17	Speedy Moisture Tester.....	20
- Aluminum can.....	17	Proctor Penetrometer Set.....	20
- Field Test Scale.....	17	Consolidation Apparatus	21
CBR Testing set		Direct Residual Shear Box.....	21
- Loading Press.....	18	Dynamic Cone Penetrometer.....	22
- Piston.....	18	Soil Surface Sample.....	22

Field Density Test



Field Density Test

Sand Cone: T-5000

To determine the density of soils. Made of Stainless steel and brass valve assembly.

- Brass valve 0.5" dia.
- Bottom 6-1/2" dia.

Base Plate: T-5010

12"x12" cast aluminum for rust resistance.

Plastic Jar: T-5020

Sand Cone Plastic jar, capacity 4 litres approx.

Stainless Steel Jar: T-5030

Stainless Steel jar, capacity can fill in to 7 litres approx.

Density Sand: H-3821

Clean, dry, free-flowing uncemented sand has few, if any, particles passing the no.200 (75 µ m) or retained on the no.10 (2mm) sieves. The sand's variation in bulk density does not vary greater than 1%.

Field Test Scale: T-6516

A simple Field Test Scale provides accurate weighing of a wide variety of heavy materials, even under the most adverse conditions.

- Capacity: 16kg.
- Readability: 5g.

Atterberg Limit Set



Plastic Limit Test Set

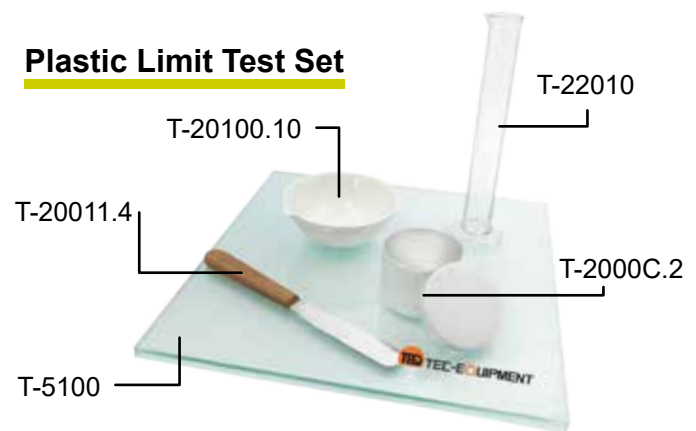

Atterberg Limit set

Atterberg Device: T-6000

Atterberg Device is a hand operated unit with counter, to determine the liquid limit of soils.

Grooving Tool

To separated into two halves in the Atterberg Device cup.

- ASTM standards model: T-6001
- AASHTO standards model: T-6002

Spatula: T-20011.4

Stainless steel blade with Wooden handle. Available for 4" and 6" Length.

Evaporation Mixing Dish: T-20100.10

made of porcelain, suitable in Laboratory to mix a material. For more detail see page 54.

Graduated Cylinder Plastic

- 100ml: T-22010

Plastic Limit Test Set

Consists of:

- Glass Plate 300mm x 300mm x10mm.: T-5100
- Mixing Dish : T-20100.10
- Spatula 4" : T-20011.4
- Graduated Cylinder : T-22010
- Aluminum Can 2": T-2000C.2

CBR Testing set



Loading Press: T-7000

Steel frame 4 columns. The machinical jack provides two speed test.

- 10,000 lbs (44kN) capacity approx.

Proving Ring: T-16006

Please see proving ring in general page for more info.

Piston: T-2020

Cylinder shape steel coated for rust resistance.

- 4" Lenght.

CBR Mold: T-7100

There are vertical splits in mold

- The internal diameter 6".
- Height: 7" and 2" of collar.

Circular Surcharge Weight: T-7200

Steel coated for rust resistance.

- Dimension: 5-7/8" OD. , 2-1/8" ID.
- 2" Height.
- 5 lbs. Weight.

Slot Surcharge Weight: T-7300

Steel coated for rust resistance.

- Dimension: 5-7/8" OD. , 2-1/8" slot.
- 2" Height.
- 5 lbs. Weight.

Filter Paper:T-7210.F

- Dimension: 6" dia.
- 100 sheets/box.

Modified Compaction Hammer: T-7400

Hand operate compaction hammer Machined steel coated for rust resistance.

- 2"dia. x 18" drop Height.
- 10 lbs weight.

Spacer Dish: T-7500

T-handle with bottom dish coated for rust resistance.

- Diameter: 5-15/16"(152mm.)
- Height: 2.416" (36mm.)

Tripod: T-7600

Supporter for deal gauge for measuring the amount of swell during soaking.

Swell Plate: T-7700

Made of brass with knurled nut for locking on stem. Base plate 5-7/8" (149.2mm.) dia.

Straight Edge: T-7800

Steel beveled edge. 300mm. Length.

Scoop: T-20002

Medium Size , made of Cast iron.

Graduated Cylinder Plastic: T-21100

1,000ml. capacity.

Square Pan: T-22424

Galvanized steel 24"x 24"x3"

Dial Indicator: T-16000

Range 0.001"x1"

Compaction Testing



Modified Compaction Hammer: T-7400
 Hand operate compaction hammer Machined steel coated for rust resistance.
 • 2”dia. x 18” drop Height.
 • 10 lbs weight.

Standard Compaction Hammer: T-7450
 Hand operate compaction hammer Machined steel coated for rust resistance.
 • 2”dia. x 12” drop Height.
 • 5.5 lbs weight.

Sample Ejector: T-2350
 Designed for eject sample. Hand operated hydraulic jack.

Straight Edge: T-7800
 Steel beveled edge. 300mm. Length.

Aluminum Can
 For more info please see Aluminum Can page.
 • Can 3oz 2” (54x35mm.): T-2000C.2
 • Can 4oz 2.5” (60x44mm.): T-2000C.2.5
 • Can 6oz 3” (70x48mm.): T-2000C.3

Rubber Mallet: T-20010
 For a softer blow with wooden handle.

Modified Compaction Mold: T-8000
 Consists of :
 • 6”diameter. x 4.584” height.
 • 6”diameter. x 2” height of collar.
 • Base plate.

Standard Compaction Mold: T-8050
 Consists of :
 • 4”diameter. x 4.584” height
 • 4”diameter. x 2” height of collar.
 • Base plate.

Scoop: T-20002
 Medium Size , made of Cast iron.

Square Pan
 Galvanized steel with wire-bound, rolled-top edges with handles to carry.
 • Galvanized steel 18”x 18”x3”: T-21818
 • Galvanized steel 24”x 24”x3”: T-22424

Trimming Knife: T-7502.T2
 design features for cutting, lashing with handle.

Sand Equivalent Testing



H-4340

Sand Equivalent Test Shaker



SD-II

Proctor Penetrometer Set



H-4139

Speedy Moisture Tester



Speedy components



Sand Equivalent Testing

Sand equivalent tests serve as rapid field-correlation tests to show relative proportions of clay-like or plastic fines and dusts in granular soils and fine aggregates. The test separates sand and clay, a comparative reading is determined between the suspended clay and the settled sand in the measuring cylinder. Tests may be done in the laboratory or the field.

Sand Equivalent Test Set: H-4340

ASTM D2419; AASHTO T176

The Humboldt sand equivalent test set includes all items required to perform a sand equivalent test except for a shaker. Be sure to choose a shaker from those offered on this page. These test sets include:

Sand Equivalent Test Shaker: SD-II

Electric Sand equivalent shaker with electronic timers. Power: 220V, 50Hz.

Proctor Penetrometer Set: H-4139

ASTM D1558

Establishes the moisture-penetration resistance relations of fine-grained soils. Includes these interchangeable needles (area in sq. in. or sq. cm):

1/6.45), 3/4 (4.84), 1/2 (3.22), 1/3 (2.15), 1/5 (1.29), 1/10 (.65), 1/20 (0.32) 1/30 (0.22cm²) and 1/40 (0.16cm²). Replacement needles available below.

Speedy Moisture Tester, L2000

Instrumentation are used for measuring the moisture content of materials including soils, aggregates, concrete, sand and powders. Principal users include geotechnical engineers on civil engineering projects, building surveyors and restorers. Other substantial user groups include mining, steel production, foundries and ceramics.

- Speedy vessel manufactured from cast aluminium and fitted with a calibrated pressure gauge.
- Electronic balance with large scale pad.
- Comprehensive user instructions.
- Waterproof and shockproof carry case with high density foam insert.

Consist of:

Large Speedy vessel fitted with Caibrated pressure gauge, electronic balance, heavy duty carry case with fitted foam inserts, cleaning brush and cloth, two steel sample-pulverising balls, measuring scoop, instructions

Norminal gross weight	6kg.
Norminal gross dimension	51x38x20cm.
Moisture measurement range	0-20% (Standard)
expressed as a percentage of	0-10% (option)
the wet weight of the sample	0-50% (option)
Sample Weight	For 0-20% mc range :20g. For 0-10% mc range :40g. For 0-50% mc range : 8g.
Maximum sample size	20mm.

Consolidation Apparatus

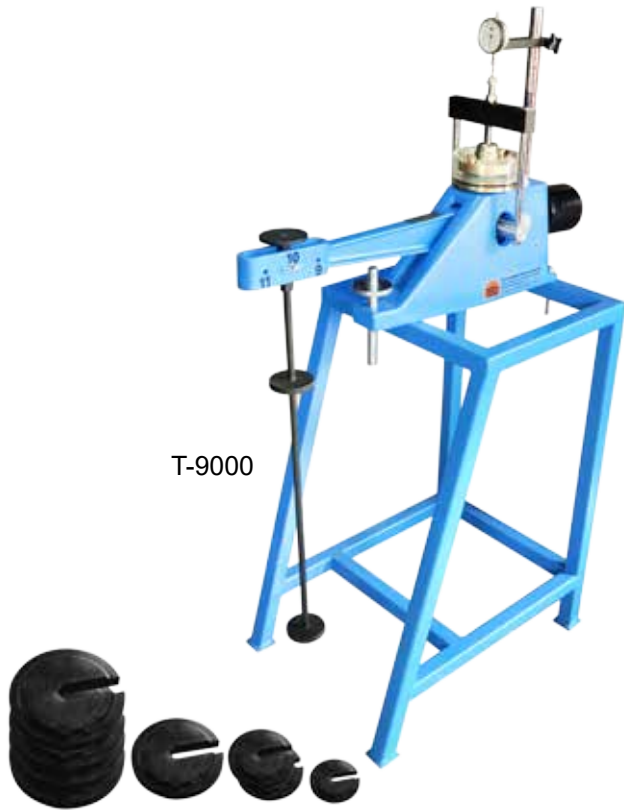

T-9000

Direct Residual Shear Box



T-9500

Consolidation Apparatus: T-9000

Standard BS 1377-5, ASTM D2435, AASHTO T216, NF P94 090-1

Soil Testing Equipments Specification

Designed to provide reliable results from a unit which is compact without sacrificing accuracy and repeatability. It comes with triple beam ratio and compact design ensures space saving.

Specifications:

- Load Capacity 8800 kPa on Dia. 50 mm Specimen
- Dimension (mm) 711 (L) x 203 (W) x 508 (H)
- Frame Cast Aluminium & Platen Steel

Consists of:

- | | |
|--|------|
| • Parts Description | Qty |
| • Basic Consolidation Unit with Hanger | 1no. |
| • Ø 50 mm Consolidation Cell | 1no. |
| • Weight Set Hanger | 1no. |
| • Dial Indicator 25 mm x 0.01 mm | 1no. |

Optional Accessories

- Weight Set 50 kg, 4 x 10 kg, 1 x 5 kg, 2 x 2 kg, 1 x 1 kg
- Weight Set 100 kg, 9 x 10 kg, 1 x 5 kg, 2 x 2 kg, 1 x 1 kg
- Table Top Bench

Direct Residual Shear Box: T-9500

Soil Testing Equipments

To determine the shear load, vertical consolidation and horizontal shear movement of the soil specimen that enclosed a robust metal box horizontally split into two halved and provided with a vertical plunger.

Consists of:

- Parts Description Qty
 - Shear Box Assembly 50 x 50mm Specimen 1set
 - Proving Ring 1 kN 1no.
 - Dial Indicator 25 mm x 0.01mm For Horizontal & Vertical Movement 2nos.
 - Hollow Punch & Tamper 50mm x 50mm Specimen 1set
 - Standard Weight Set 50 kg 1set
 - Vertical Load Hanger 1no.
- Optional Accessories
- Proving Ring 3 kN
 - Standard Weight Set 50 kg

Specifications

Vertical Loading	50, 100, 200, 300, 400 kPa
Max. Shear Force	3 kN
Shear Rate	0.02, 0.8, 2.4 mm / unit
Level Arm Ratio	1 : 10
Fast / Forward	10 mm / min
Reverse Speed	
Approx. Weight	82 kg
Power	220 - 240 V, 1 ph, 150 W

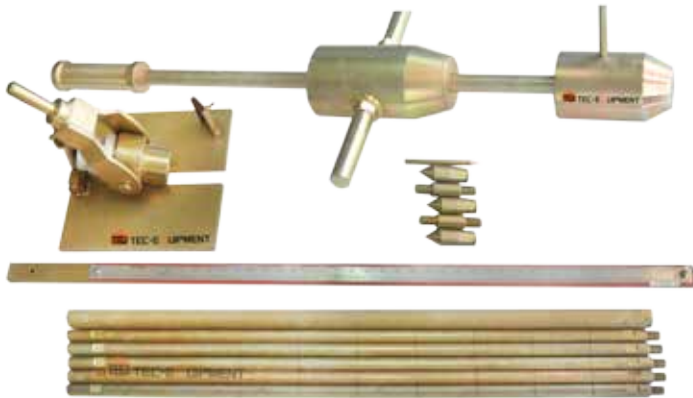
Dynamic Cone Penetrometer

T-9600

Dynamic Cone Penetrometer: T-9600

The Dynamic cone penetrometer used for geotechnical and foundation engineering for site investigation in support of analysis and design.

Consist of:

Cone, Cone Adapter, Pointer, Drop Hammer, Bottom Rod, Ruler, Lifting Device, Handle for Lifting Device

Soil Surface Sample

T-9700

Soil Surface Sample: T-9700

Monitoring soil fertility levels will save you money. The greatest return on investment is obtained when fertilizer and lime rates are based on soil test results.

Machined steel, coated by galvanized.

- 69 cm. Length. and Handle.



cement

Cement Section:

Product	page	Product	page
Cement Automated Compression.....	25	- Conical Mold, Plastic.....	27
Cement computer controlled machine.....	25	- Conical Mold, Brass.....	27
Three Gang Mold - Cast Iron.....	26	Measured 400ml Mold, Brass.....	27
Three Gang Mold - Brass.....	26	Test Sand, ASTM 20-30.....	27
Briquette- Brass.....	26	Ottawa Test Sand for Cube Molds.....	27
Prism Mold 40x40x160mm.....	26	Vicat Apparatus.....	28
Prism Mold 25x25x285mm.....	26	Vicat Automatic.....	28
Prism Mold 75x75x254mm.....	26	Length Comparator, Dial Indicator.....	29
Studs.....	26	Blaine Air Permeability Apparatus.....	30
Mixer.....	26	Organic Impurities Test Set.....	30
Flow TabeL Test Set		Organic Color Wheel.....	30
- Flow Table.....	27	Sodium Hydroxide Beads.....	30
- Flow Mold.....	27	Graduated Bottle.....	30
- Caliper.....	27	Water Retention Apparatus.....	31
- Tamper.....	27	Gillmore Apparatus.....	31

Automatic Cement compression machines



Cement Automated Compression / Flexural Tensile Machines (Three Frames)

Standard: BS EN 196-1, BS 4550, BS 4554, ASTM C-109, ASTM C-190

The Automatic Compression / Flexural / Tensile (Briquette) Test Machines are designed to test cement specimen size 40 x 40 x 160mm, 75mm, 70.7, 50mm cube and briquette tensile test accordance to above measure standard. The loading rate and the operated function, data, result and print unit are automatically controlled by microprocessor technology. The advantages of this machine are built-in with 3 section of capacity from frame to frame that brings all the test relevant standard together in one comprehensive operation function.

Specifications:

- Fully automatic with microprocessor control
- Calibration accuracy to EN 12390 Class 1.0, ASTM E-4, ISO 370
- Meet BS EN 196-1, BS 4550, ASCTM C-109, ASTM C-190
- Large digital display size 125 x 75mm screen
- Compression Range: 0-25kN x 0.01, 25-250kN x 0.1kN per increment
- Flexural / Tensile (Briquette) Range: 0-10kN x 0.001kN per increment
- Measurement Range (Compression): From 2 to 250kN
- Measurement Range (Flexural/Tensile): From 0.5 to 10kN
- Specimen to be test(mm): 75mm, 70.7mm, 50mm cube, 40 x 40 x 160mm prism (compression / flexural) and briquette specimen (tensile)

Model Available

ADS 25/10ENT-3, Fully Automated 250/10kN (Three Frame)
Compression / Flexural / Tensile Test Machine

Cement computer controlled Flexural and compression testing machine: CXYAW-300S

Fully automatic cement , flexure and compression testing machine.

The frame is innovation designed according to human body mechanics principle , it makes easy operation , accuracy test and highly improves the operating comfort level of operating.

- It utilizes double load sensors as acquisition unit, with very good stability, high force resolution(up to1/300000) ,highly improved the test result accuracy,up to 0.5 grade.
- Effectively control the noise without load is lower than 40dB, noise with load is lower than 55dB.

Software

- The software supports synchronously control compression and flexural, highly improve the machine efficiency.
- The function of operating guide, error alarm.
- The result can be derived into Excel format.

Specifications:

Max test force	300kN , Flexural: 10kN
Control load rate range	Compression 0.05-10kN/s Flexural 0.1-200N/s
Ball screw stroke	Compression 120mm. Flexural 150mm. 300mm.
Distance upper and lower pressure platen	
Motor power	Compression 400W Flexural 40W
Outline dimension (approx)	
Control cabinet	510x450x940mm.
Main frame	540x420x1490mm.
Main frame weight	350kg.

Cement Mold

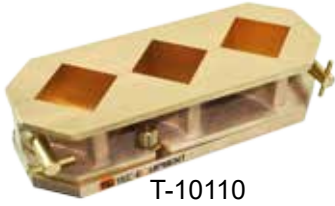

T-10110



T-10446



T-10100



T-10228



T-10120



T-10776

Three Gang Mold - Cast Iron: T-10100

Three gang mold cube sample of Cement mortar, lime and gypsum. Split type mold. Screw clamps held in place by snap rings.

- 50 x 50 x 50mm.
- Made of Cast Iron.

Three Gang Mold - Brass: T-10110

Three gang mold cube sample of Cement mortar, lime and gypsum. Split type mold. Screw clamps held in place by snap rings.

- 50 x 50 x 50mm.
- Made of Brass.

Briquette- Brass: T-10120

Three gang Briquette- for cement mortar tensile strength tests. Screw clamps held the two part.

- Made of Brass.

Prism Mold: T-10446

Prism mold 40x40x160mm., three gangs. To determine the thermal properties in drying shrinkage of concrete. The mold made of steel.

- Studs order separately.

Prism Mold: T-10228

Prism mold 25x25x285mm., two gangs. To determine the thermal properties in drying shrinkage of concrete. The mold made of steel.

- Studs order separately.

Studs: T-10776

The Studs made of steel for use with Prism Mold.

Mixer



T-11005.2



T-11005.1



T-11005

Prism Mold: T-10775

Prism mold 76x76x254mm., available two gangs and three gangs. To determine the thermal properties in drying shrinkage of concrete. The mold made of steel.

- Studs order separately.

Mixer

Bench model unit for mixing cement paste and mortars. Includes Bowl and Beater. Power: 220V, 50Hz.

Capacity	Model.
5 litres	T-11005
10 litres	T-11010
20 litres	T-11020

Beater

The beater made of stainless steel for mixing heavy materials

For Capacity	Model.
5 litres	T-11005.2
10 litres	T-11010.2
20 litres	T-11020.2

Bowl

For Capacity	Model.
5 litres	T-11005.1
10 litres	T-11010.1
20 litres	T-11020.1

Flow Table Test



Flow Table: T-11200

Flow Table uses for measuring the consistency of cement mortar and Hydrated lime. Hand driven control.

- Cast iron steel frame
- Brass Table 10" dia.
- 0.5" drop

Flow Mold: T-11201

Made of Brass.

- Top 2.75" (69.8 mm.) dia.
- Bottom 4" (101.6 mm.) dia.
- Height 2" (50.8mm.)

Caliper: T-11202

For measure mortar flow on the Flow table diameter.

Tamper

- Tamper, Wood : T-11203.1
- Tamper, acrylic: T-11203.2

Conical Mold, Plastic: T-11204

Plastic mold, 70mm bottom dia. x 60mm top dia. x 40mm high. For use with all Vicat apparatuses. Conical Mold, Plastic

Conical Mold, Brass: T-11205

Brass mold, 70mm bottom dia. x 60mm top dia. x 40mm high. For use with all Vicat apparatuses. Conical Mold, Brass.

Conical Mold, Brass: T-11206

Brass mold, 76mm dia. x 40mm high. For use with vicat apparatus. Conical Mold, Brass

Measured 400ml Mold, Brass: T-11207

For determine air content of hydraulic cement mortar. Brass measure 400ml, 76mm dia. x 88mm depth approximately.

Test Sand, ASTM 20-30: H-3820BX

ASTM C91, C141, C185, C359, C778; AASHTO T132, T137, T185

Sand is specially graded natural silica sand to pass a No. 20 (850µ) sieve. Specific gravity is 2.65.

Packed in 50 lb. (22.7kg) boxes

- Test Sand, ASTM 20-30, box

Ottawa Test Sand for Cube Molds: H-3825BX

ASTM C87, C109, C348, C359, C593, C778; AASHTO T71, T106, T185

Sand is specially graded natural silica sand graded to retain

98% on a No. 100 (150µ) sieve,

75% on a No. 50 (300µ)

30% on a No. 40 (425µ)

2% on a No. 30 (600µ).

Specific gravity is 2.65.

- Packed in 50 lbs. (22.7kg) boxes.

Vicat Test

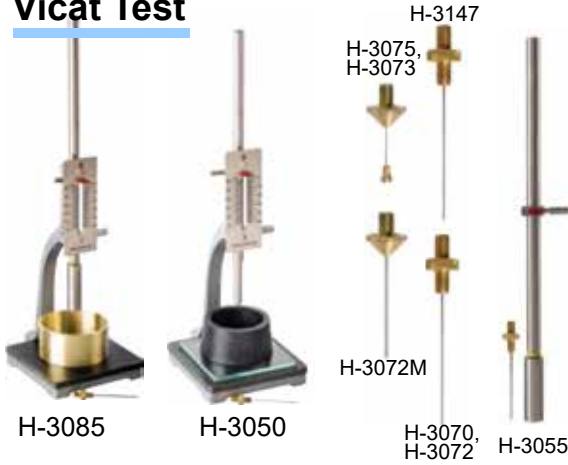

Vicat Consistency Apparatus: H-3050

ASTM C91, C141, C187, C191, C308, C451, C472; AASHTO T129, T131, T186
 Reversible stainless steel plunger with 10mm dia. on one end and threaded, H-3070 1mm dia. stainless steel needle on the other. Weight of plunger assembly with adjustable indicator is 300g total. This includes the 1mm stainless needle. Graduated 0-50mm scale.
 Includes frame with bakelite platform, graduated 0-50mm scale, reversible plunger assembly with H-3070 1mm diameter stainless steel needle, H-3080 conical mold and H-3049 glass plate.

Vicat Apparatus, Set Time & Consistency:

H-3085
 ASTM C807
 Designed to switch between 17.5mm dia. plunger for consistency determinations and a 2mm dia. needle for time of set determinations. Plunger assembly with adjustable indicator weighs 400g with 17.5mm needle attached and 300g with 2mm needle.
 Includes graduated 0-50mm scale, frame

Conical Mold, Plastic: H-3080
 Plastic mold, 70mm bottom dia. x 60mm top dia. x 40mm high. For use with all Vicat apparatuses.

Conical Mold, Brass: H-3086
 Brass mold, 76mm dia. x 40mm high. For use with H-3085 vicat apparatus. Conical Mold, Brass

Glass Plate: H-3049
 Glass plate, 4"x 4"x .1375" (101.6mmx101.6mmx4.8mm).

Needle

1mm dia. stainless steel with knurled threaded holder	H-3070
1.13mm dia. stainless steel with knurled threaded holder	H-3072
2mm dia., stainless steel vicat needle for H-3050	H-3147
Initial set needle, 1.13mm dia. x 45mm, BS EN 196-3. for H-3085	H-3072M
Final set needle, 1.13mm dia., BS EN 196-3.	H-3073
Initial and final set needle, ASTM C191	H-3075
17.5mm dia., stainless steel vicat needle	H-3085.1.1

Automatic Vicat Test

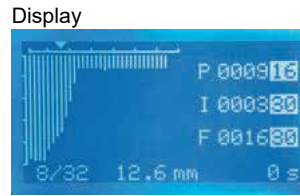

Vicat Machine, Automatic: E044N
 ASTM C191, AASHTO T131, EN 196-3, DIN 1164, DIN 1168 gypsum, NF P15/431 and BS4550

The Vicatronic apparatus, that is designed and manufactured using the most recent and sophisticated technology, is used for the initial and final setting time determination of cements or mortar pastes.
 The unit is manufactured with "anticorrosion and tropicalised" components to be used in places with humidity not below 90% and 20°C. controlled temperature as required by EN Specifications.
 The entire test is made in a fully automatic way and gives a very precise and repeatable result. The results are printed on the incorporated printer and this eliminates the manual operations of installing and zeroing the paper graph on the drum.
 The use of the appliance is extremely simplified by the guiding menu that is available in english, french, spanish, german, polish, italian language.

The Vicatronic is supplied complete with the incorporated printer, two hardened needles 1 mm dia and 1,13mm. two conical moulds EN and ASTM, a glass plate to hold the conical mould.

Power supply: 230 V 1 Ph 50/60 Hz. 50W
 Dimensions: 400 x 200 x 470 mm. h.
 Weight: 13 kg.



Spare Parts:
 E046N 1,13 mm. Ø hardened needle (EN 196-3:2005)
 E046-01N 1 mm. Ø hardened needle (ASTM)
 E055-05 Plastic mould Ø 60/70 x 40 mm. high ASTM
 E055-07 Glass base plate
 E055-10 Plastic mould Ø 70/80 x 40 mm. high EN, NF
 E042-06N Probe 300 g to EN 196-3:2005
 E044-48N Tang to fix the needle to the probe
 C127-11 Thermo-paper roll for printer (pack of 10 rolls)
 E044-45 Additional 700 g weight (EN, NF)

Length Comparator



H-3250



H-3250D.4F



See table below



T-10776

Length Comparator, Dial Indicator

ASTM C151, C157, C227, C311, C341, C342, C452, C490, C596; AASHTO M210, T107, T160.

Length comparators measure length changes of hardened cement paste, mortar and concrete prismatic specimens. Indicators are mounted on a sturdy upright support attached to a solid triangular base. All units include stationary and movable anvils designed to fit H-3260 gauge studs, which are cast into test specimens and an invar reference bar. Comparators for 10" (254mm) or 16" (406mm) effective length samples with 3.625" (92mm) dia. dial gauge with a range of .400" and graduations of .0001". The Dial is marked 0-10. Includes stationary and movable anvils designed to fit the H-3260 gauge studs that are cast on test specimens and an invar reference bar. Unit accommodates test specimens up to 4" x 4" (102 x 102mm) cross section.

Length Comparator, 10" Effective Length: H-3250
 Length Comparator, 16" Effective Length: H-3248

Studs: T-10776

The Studs made of steel for use with Prism Mold.

Length Comparator, Digital Indicator

ASTM C151, C157, C227, C311, C341, C342, C452, C490, C596; AASHTO M210, T107, T160.

Length comparators measure length changes of hardened cement paste, mortar and concrete prismatic specimens. Indicators are mounted on a sturdy upright support attached to a solid triangular base. All units include stationary and movable anvils designed to fit H-3260 gauge studs, which are cast into test specimens and an invar reference bar. Comparators for 10" (254mm) or 16" (406mm) effective length samples with digital indicator with a range of .600" and resolution of .0001". Measures inches and millimeters includes batteries and AC adapter. Unit can be zeroed at any point on the range and can be switched from inches to mm by pressing a button. Includes stationary and movable anvils designed to fit the H-3260 gauge studs that are cast on test specimens and an invar reference bar. Unit accommodates test specimens up to 4" x 4" (102 x 102mm) cross section.

Length Comparator, 10" Effective Length 220V 50/60Hz: H-3250D.4F

Length Comparator, 16" Effective Length 220V 50/60Hz: H-3248D.4F

Comparator Replacement Components

Description	Model
Invar reference bar for use with H-3250 and 10" (254mm) specimens	H-3249A
Invar reference bar for use with H-3248 and 16" (406mm) specimens	H-3249A.16
Dial indicator	H-3250.3
Digital indicator, 120V 60Hz	H-3250.3D
Digital indicator, 220V 50Hz	H-3250.3D.4F
Anvil with collar (one each)	H-3250.4
Anvil only	H-3250.4.4
Collar only	H-3250.4.3
Elevating screw, nut collar & anvil assembly	H-3250.7
Adapter for 5" specimens	H-3250.8

Blaine Air Permeability

H-3810



H-3812



H-3813B



H-3811



H-3816



H-3817.20



H-3817



H-3814

Organic Impurities Test Set

H-3493A



H-3492A



H-3491



H-3490A

Blaine Air Permeability Apparatus

ASTM C204; AASHTO T153

Determines fineness of Portland cement in terms of specific surface expressed as total surface area in square centimeters per gram of cement. Consists of: calibrated U-tube manometer, ground glass joint, stainless steel test cell and plunger, rubber aspirator bulb and perforated disc.

Includes 8 oz (226.8g) bottle of red manometer fluid, filter paper, wood block for holding test cell during filling and funnel. Mounted on finished wood panel with rubber-footed base.

Blaine Air Permeability Apparatus: H-3810

Spare part

Rubber bulb

H-3811

Cell and plunger

H-3812

Perforated brass disc

H-3813B

Manometer fluid, 8oz (240ml)

H-3814

Mercury (TEQ/Thailand)

Organic Impurities Test Set

Organic Impurities Test Set: H-3493A

Test Set, w/o Sodium Hydroxide: H-3493AX

ASTM C40; AASHTO T21

Determines presence of injurious organic compounds in sands used in cement mortar or concrete. Test serves as warning that further tests of sands are necessary before they can be approved for use. Air shipments must meet Dangerous Goods requirements because of Sodium Hydroxide Beads. Order H-3493AX without Sodium Hydroxide Beads to avoid Dangerous Goods requirements.

Organic Color Wheel: H-3492A

ASTM C40; AASHTO T21

Color comparison wheel for use with organic impurities test. Color wheel has five different color filters to compare to test solution.

Sodium Hydroxide Beads: H-3491

1lb (454g) Container of Sodium Hydroxide Beads. Air shipments must meet Dangerous Goods requirements.

Graduated Bottle: H-3490A

12 oz. (.35L) graduated bottle for organics impurities test.

Water Retention Apparatus

Gillmore Apparatus



Water Retention Apparatus: H-3630A
 ASTM C1506, C110, C207 and E149
 The apparatus is used in specification tests of masonry cement and physical testing of quicklime and hydrated lime. Unlike older models, this unit incorporates a vacuum regulator and gauge system in place of the old mercury manometer and relief column. The complete unit consists of an aspirator pump, vacuum regulator, vacuum gauge, three-way stopcock, flask, rubber gasket, brass funnel, perforated brass dish, filter paper and hardwood stand.

Gillmore Apparatus: H-3150
 ASTM C91, C141, C150, C266, C414; AASHTO T154
 Used to determine initial and final set times of Portland cement, masonry cement, hydraulic hydrated lime and certain mortars. Comprised of two stainless steel needles with 0.0375" (4.8mm) cylindrical flat-end needles. One is 1/12" (2.12mm) dia. 1/4lb. (113.4g) weight for initial set. The second is 1/24" (1.06mm) dia., 1lb (453.6g) weight for final set.

Water Retention Apparatus Replacement Parts

Gillmore Apparatus spare parts.

Funnel	H-3630.3
Stopcock	H-3630.4
Rubber gasket	H-3630.18
Filter paper, 15cm, package of 100	H-3630.21
Perforated brass dish	H-3631
Flask, 1000ml	H-4913.1M

Strike-off plate, 0.5" thickness	H-3154
Needle, 1/24" (1.06mm) dia. with 1lb (453.6g) weight	H-3151
Needle, 1/12" (2.12mm) dia. with 1/4lb. (113.4g) weight	H-3152
Gillmore needle, 0.050" dia.	H-3152.4



concrete

Concrete Section:

Product	page	Product	page
Digital compression machine.....	33	Acme Penetrometer.....	39
Compression Machine Gauge Type ,DC.....	34	Rebound Concrete Test Hammers.....	40
Compression Machine Gauge Type, AC.....	34	Anvil.....	40
Fully automatic compression machine.....	35	Ultrasonic Pulse Velocity Series	
Cube mold 10x10x10cm,high standard.....	36	-Ultrasonic pulse velocity tester.....	42
Cube mold 15x15x15cm ,economy.....	36	-Pundit series.....	41
Cube mold 15x15x15cm,high standard.....	36	Rebar Locator Series	
Cylinder mold 10x20cm.....	36	-Profoscope+.....	42
Cylinder mold 15x30cm.....	36	-Zircon MT6.....	42
Beam Mold 15x15x60cm.....	36	-Profometer series.....	43
Beam Mold 15x15x75cm.....	36	Corrosion, Half cell	
Econ-O-cap.....	36	-Profometer Corrosion.....	43
Rubber Pad.....	36	-Xcell.....	44
Vertical Cylinder Capping.....	36	Resistivity	
Capping Compound.....	36	-Resipod.....	44
Melting Pod.....	36	-Surf.....	45
Slump Test Set		-Perma2.....	45
- Slump cone.....	37	-Rcon2.....	45
- Tamping Rod.....	37	Pull off tester.....	46
- Cube Tamper.....	37	Smart Box.....	46
- Square Pan.....	37	Smart Rock2.....	46
- Plate.....	37	L-Shape Box.....	47
Compacting Factor.....	37	U-Shape Box.....	47
Unit Weight Measures.....	37	V-Funnel.....	47
Air Meter.....	38	Cutting machine.....	47
Mortar Penetration Resistance Apparatus.....	39		

Digital compression machine

2000kN and 3000kN

BS 1610/1881, ASTM E4/C39 , AASHTO T2

Four prestressed columns mechanical frame are prestressed with a special procedure. Load capacity and simply locked in position by the bolt, while the four tubes are compressed to the same value. This create the static balance inside the testing space of the machine for any testing load assuring the maximum stability and rigidity. These compression machine designed for use both in field and laboratory for the testing.

The high value low pressure feature. Fitted with special pressure - compensated flow control valve which allows a precise of loading over the complete test.

Automatic stop when the piston stroke reach the limit protection switch.

For testing: 15cm x15cm. Cube

15cm x30cm. Cylinder specimen.

Available in: 2000kN and 3000kN capacity.

- Econ cap test needs to order a Lower platen separatly.

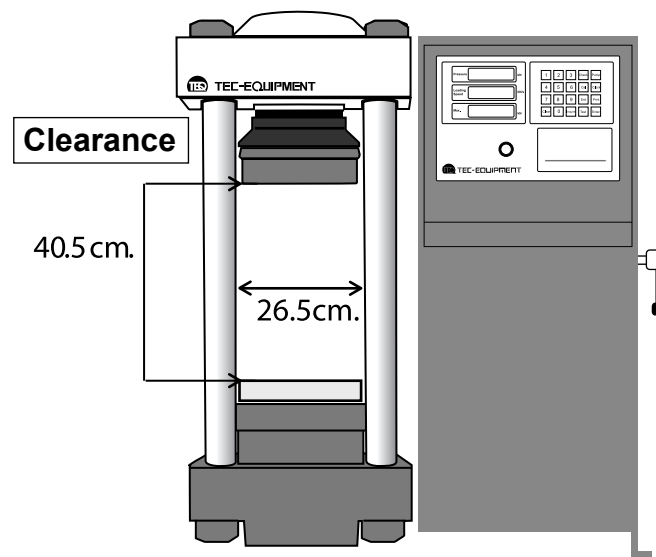

Specification

Model	YE-2000C	YE-3000C
Maximum Capacity	2000kN	3000kN
Readout unit	Digital Display	
Accuracy	+/-1%	
Vertical Clearance (approx)	450mm.	450mm.
Horizontal Clearance (approx)	265mm.	350mm.
Testing Range	0 - 2000kN	0 - 3000kN
Piston stroke	50 mm.	
Weight	800kg.	1000kg.
Steel Platen:	Ø29.5cm x 3.5cm.	
Top	Ø19.6cm x 5cm. One piece	
Support Steel Platen	Ø19.6cm x 19.8cm. Two pieces	
Power	220V 1ph	

Compression Machine Gauge Type



YE-2000G



T-C1500.G



T-C2000.G

Compression Machine Gauge Type,DC motor

Compact and simple design for maximum rigidity simple to operate, high specification.

The machine has the gauge control for using the high pressure gauge up to the frame's capacity.

The gauge diameter 200mm.(approx) in 2000kN model and 300mm.(approx) in 3000kN model.

Supplied complete with platens for testing standard 15x15cm cube and 15x30cm cylinder specimen.

Available in: 1500kN and 2000kN capacity.

Model	YE-2000G
Maximum Capacity	2000kN
Vertical Clearance (mm.)	450
Accuracy	+/-1%
Diameter Gauge (mm.)	270 approx.
Piston stroke	50 mm.
Hydraulic Power pump	Manual
Power Supply	220v. 50Hz

Compression Machine Gauge Type,AC motor

Compact and simple design for maximum rigidity simple to operate, high specification.

The machine has the gauge control for using the high pressure gauge up to the frame's capacity.

The gauge diameter 200mm.(approx) in 2000kN model and 300mm.(approx) in 3000kN model.

Supplied complete with platens for testing standard 15x15cm cube and 15x30cm cylinder specimen.

Available in: 1500kN and 2000kN capacity.

Model	T-1500G	T-2000G
Maximum Capacity	1500kN	2000kN
Ram Stroke (mm.)	50	
Max Vertical Clearance (mm.)	330	340
Diameter Gauge (mm.)	200	300
Pressure Seal	Poly Seal	
Hydraulic Power pump	Manual	
Power Supply	220v. 50Hz	

Automatic Compression Test Machine



AUTOMATIC COMPRESSION TEST MACHINE

The automatic console is providing control for the main Compression Frame and the optional Flexural frame. LCD display has an Auto cut off system which provide longer life spend for the display.

All parameters such as pace rate, sample size, time, date, etc. are entered by using the touch sensitive keypad and function key.

The calibration and engineering data are protected by pass code and test result can be viewed and stored up to 300 numbers test which can be connected to optional printer or P.C by using RS 232 cable.

LCD can be enlarged 4 times larger for better clear view.

The Unit is displayed in kN, kgf or lbs and associated in mm or inches unit. The measuring system and hydraulic pump are control by microprocessor and keypad data entry. The auto rapid approach system is provided in the test and load control is based on Servo motor which is more accurate and reliable control of loading rate to the specimen.

Capacity available 1500kN, 2000kN, 3000kN, and 4000kN and 5000kN capacity.

Compression mode

- a) Low range 0-400 x 0.1kN
- b) High range 400-2000, 2500, 3000 x 1kN
- High range 400-4000, 5000 x 1kN

Flexural mode

- a) Flexural range 0-100 x 0.01kN or 0-250kN x 0.01kN

Fully Automatic Autocon Digital Specifications

- 5 stage fine time test
- 3 channel digital readout
- Displays calculated density (kg/m)
- Large graphics LCD Display Screen, size: 100mm x 150mm in kN units
- Calibrated through keypads (password protected)
- Pace rate setting facility from 0.1 to 15.0kN per sec.
- Digital pace rate indicator for manual control
- Real time clock and calendar
- Specimen test number with automatic increment
- Automated close control of the selected pace rate
- -x-y Graphic display Force against Time (s)
- -x-y Graphic display Force against deformation(optional) for elastic modulus test
- Part for hook – up to computer and printer
- in kN made reading, 0.1kN increment up to 400kN then 1kN increment up to 2000kN, 2500kN, 3000kN, or 4000kN, 5000kN
- Screen display failure load (kN) and stress (Mpa) in engineering units, test number, pace rate (kN/s), Specimen size (mm), date and time
- Automatic closure daylight, zeroing and taring during pretest platen movement.
- Rapid throughout of concrete test
- Complete test can be carried out from the push of a button.
- Manual over-ride for the operator control
- Test result can be viewed, stored up to 300 test before requiring downloading to computer
- Print out result
- Selection of sample type and size
- Metric (kN) or imperial (lbs) and (kgf) selection
- Auto release when sample failure
- Power: 240V, 50Hz, 1pH

Concrete Mold



Cast Iron Mold

Cube mold and Cylinder mold are made of cast iron and split three parts. Molds give accurate specimens for loading tests and get a better result.

Cube Mold

Model	Size	Weight (approx)
T-121010	10x10x10cm.	7.8kg.
T-121515	15x15x15cm.	9.8kg.
T-121515H	15x15x15cm.	13.2kg.

Cylinder Mold

Model	Size	Weight (approx)
T-121020	10x20cm.	7.4kg.
T-121530	15x30cm.	11.8kg.

Beam Mold

Model	Size	Weight (approx)
T-121560	15x15x60cm.	40kg.
T-121575	15x15x75cm.	45kg.

Tamping Rod: T-13010
Steel galvanized 16mm dia. x 600 mm height.

Cube Tamper: T-13020
Machine Steel 1x1 inch. with Handle.

Econ Cap



Tamper



Capping Test Set



Econ cap: T-12500
Precision - machined high-alloy steel raining caps retain compression pads that fit over the ends of the concrete cylinder.

Rubber Pad: T-12510
60 Durometer Hardness.

Vertical Cylinder Capping
Vertical Capper 4" dia.: T-12520.4
Vertical Capper 6" dia.: T-12520.6

Yellow Sulphur Powder: T-12530
Capacity: 25kg.

Melting Pot: T-12540
For Capping compound, adjustable thermostat temperature over 95C
Size : 19 cm. dia x 13.5 cm.
Power : 220v 50Hz 1ph.

Ladle: T-20054
A ladle used for Yellow sulphate to pour in a vertical capper and also for other material.

Slump Test Set



T-13001



T-13002

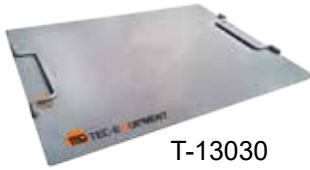

T-13030



T-20002



T-13010



T-21818



T-22424

Unit Weight



T-14003



T-14010



T-14015



T-14030

Compacting Factor



T-13100

Slump Test Set

Available in two type

- Zinc coated steel: T-13001
- Stainless steel: T-13002

Specification:

- Dia at top 100 mm.
- Dia at base 200 mm.
- Hight 300 mm.

Tamping Rod: T-13010

Steel galvanized 16mm dia. x 600 mm height.

Scoop

Cast Iron materials, for general purpose. Round bottom aviable for

- Small size: T-20001
- Medium size: T-20002
- Large size: T-20003

Square Pan

- Galvanized steel 18"x 18"x3": T-21818
- Galvanized steel 24"x 24"x3": T-22424

Compacting Factor: T-13100

For determination of the compacting factor of concretes with low, medium and high workability. Composed of two hoppers with trap doors Mounted vertically above a cylindrical mould.

Accessories:

- Tamping Rod
- Scoop

Unit Weight Measures

Cylindrical machined steel with handles for determining Unit weight of fine. Coarse or mixed aggregates. Water-tight with true and even top and bottom. Measure retain form after repeated use.

Container:

- 3 litres capacity: T-14003
- 10 litres capacity: T-14010
- 15 litres capacity: T-14015
- 30 litres capacity: T-14030

Plate: T-13030

Size 300 x 400 mm. comes with two Handles.

Air Meter Test



H-2783

Humboldt Concrete Air Meter: H-2783 ASTM C231, AASHTO T152

The H-2783 air meter features the Humboldt, allbrass super pump, the most reliable and highest quality pump available. The meter's easy-to-use, stainless steel clamping system employs four, onepiece, self-locking clamps that quickly seal the lid to the base with proper tension aided by an o-ring to assure a watertight seal. A large, easy-to-read, 4-inch diameter, direct percentage gauge with calibration adjustments is accurate to the nearest 0.1%. The bucket features cast handles, which improve usability, especially when using bucket as a 0.25 cu. ft. unit weight measure. The lid of the pressure meter features a smooth sloped top so water and concrete wipe right off. By eliminating the cavities in the lid that trap and hold concrete, maintenance and repair problems are greatly reduced. The meter also features a machined base, which ensures the meter sets level when conducting tests. The kit includes a durable plastic carrying case; a tamping rod; strike-off bar; rubber bulb syringe; plastic calibration vessel; inside calibration tube, outside calibration tube and operating instructions.

Humboldt Concrete Air Meter



H-2786P

Press-Ur-Meter Concrete Air Meter: H-2786P ASTM C231, AASHTO T152

This is the original Press-Ur-Meter for field and laboratory tests. This air meter is designed to provide air content and the determination of specific gravity and free moisture of aggregate. Designed to save time, reduce water use, ensure accuracy and maintain sample integrity (sample may also be used for slump and compression tests). The meter uses brass cover clamps, which can be adjusted for clamping pressure. A large, easy-to-read, 4" diameter, direct percentage gauge with calibration adjustments is accurate to nearest 0.1%. The H-2786 meter also features the Humboldt, allbrass super pump, the most reliable and highest quality pump available. The meter's base/bucket can be used as a 0.25 cu. ft. unit weight measure. The kit includes a wood or molded-plastic carrying case; tamping rod; strike-off bar; rubber bulb syringe; aluminum calibration vessel; inside calibration tube, outside calibration tube and operating instructions.

Press-Ur-Meter Concrete Air Meter

Air Meter Replacement Accessories

Item	Part No.
Calibration Vessel, plastic	H-2783.30
Calibration Vessel, metal	H-2785.31
Calibration Tube (outside)	H-2785.32
Calibration Tube (inside)	H-2785.33
Wash Bottle	H-3399
Strike-off Bar	H-2785.34
Tamping Rod 5/8" x 16"	H-2785.35
Syringe, Rubber Bulb	H-2785.36
Plastic Case, Horizontal	H-2783.62H
Wooden Case, Press-Ur-Meter	H-2785.38
Plastic Case, Press-Ur-Meter	H-2785.38HP



H-2789



H-2793



H-2788

Air Meter Calibrators (5%)

Calibrators check the accuracy of any pressure-type concrete air meter. Set the specially-designed canister upright at the bottom of the water-filled base, and the meter should read 5% air by volume. Two calibrators are used for a 10% air reading.

Air Meter Calibrator, Brass	H-2789
Air Meter Calibrator, Aluminum	H-2793
Air Meter Calibrator, Plastic	H-2788

Mortar Penetration Resistance Apparatus



H-4137

Acme Penetrometer



H-4133

Mortar Penetration Resistance Apparatus:

H-4137
 ASTM C403, AASHTO T197
 Spring-reaction-type apparatus, graduated from 10 to 130 lbf (45 to 580N) in increments of 2 lbf (9N) for testing rate of hardness of mortars sieved from concrete mixtures. Determines effects of variables such as temperature, cement, mixture proportions, additions and admixtures upon the time of setting and hardening of concrete. Penetration resistance is measured by the downward vertical force exerted to penetrate the mortar 1" (25mm). Pressure reading is measured by a scale with a sliding ring indicator on the handle's stem. Includes these interchangeable mortar penetration resistance needles: 1, 1/2, 1/4, 1/10, 1/20 and 1/40 sq. in (645, 323, 161, 65, 32, 16mm²).
 Mortar Penetration Resistance Apparatus

Resistance Needle Set

ASTM C403, AASHTO T197
 Set of six, screw-on type, replacement needles for use with the H-4137 mortar penetration resistance apparatus. Set includes: 1, 1/2, 1/4, 1/10, 1/20 and 1/40 sq. in (645, 323, 161, 65, 32, 16mm²).
 Resistance Needle Set H-4143

Resistance Needles, Individual

ASTM C403, AASHTO T197
 Screw-on type, replacement needles for use with H-4137 mortar penetration resistance apparatus. Purchase individually.43

Description	Part No.
1 sq. in. (645mm ²)	H-4143.1
1/2 sq. in. (323mm ²)	H-4143.50
1/4 sq. in. (161mm ²)	H-4143.25
1/10 sq. in. (65mm ²)	H-4143.10
1/20 sq. in. (32mm ²)	H-4143.05
1/40 sq. in. (16mm ²)	H-4143.025

Acme Penetrometer: H-4133

ASTM C403, AASHTO T197
 Hydraulic reaction-type apparatus for determining the setting time of concrete with slump greater than zero by testing mortar sieved from the concrete mixture. It also determines the effects of variables, such as temperature, cement, mixture proportions, additions and admixtures upon the time of setting and hardening of concrete. The penetrometer's design makes it easy to operate, being more efficient, with a longer gear rack. All needles are one length so settings may remain the same. Loads are applied hydraulically with pressures read on a 200 lbf (890N) capacity gauge graduated in 2 lbf divisions. Set of six needles allows multiplication to a maximum reading of 8000 lbf. The acme penetrometer features cast aluminum base and set of stainless steel penetration needles in a wooden block (bearing area: 1, 1/2, 1/4, 1/10, 1/20 and 1/40 sq. in., (645, 323, 161, 65, 32 and 16mm²). Includes 100 laboratory test data reporting forms.

Resistance Needle Set

ASTM C403, AASHTO T197
 Set of six, stainless steel needles and holding block for use with the H-4133 acme penetrometer mortar penetration resistance apparatus. Set includes: 1, 1/2, 1/4, 1/10, 1/20 and 1/40 sq. in (645, 323, 161, 65, 32, 16mm²).

Resistance Needles, Individual

ASTM C403, AASHTO T197
 Individual replacement needles for use with H-4133 acme penetrometer. Purchase individually.

Description	Part No.
1 sq. in. (645mm ²)	H-4133.15
1/2 sq. in. (323mm ²)	H-4133.16
1/4 sq. in. (161mm ²)	H-4133.17
1/10 sq. in. (65mm ²)	H-4133.18
1/20 sq. in. (32mm ²)	H-4133.19
1/40 sq. in. (16mm ²)	H-4133.20

Concrete Test Hammer Series



Original Schmidt

Silver Schmidt

C380

C390

C381

Rebound Hammer Standards

The SilverSchmidt is fully compliant with ASTM C805, EN 12504-2 and EN 13791. The Chinese standard been applied in SilverSchmidt for the procedure to determine the rebound number. The Original Schmidt is fully compliant with all major standards. Each rebound hammer is built for a different purpose in order to meet the specific needs of the customer. The following table gives an overview of the specifications and applications for each instrument.

Original Schmidt Type N

Measuring range 10 to 70 N/mm² compressive strength (below 25 N/mm² type P is better suited).

Impact energy = 2,207 Nm.

Rebound values are read from a dial. Testing the compressive strength of a prefabricated concrete girder. Rebound values are recorded by an assistant who will calculate mean values and read compressive strength values from a conversion diagram.

SilverSchmidt ST/PC Type N/L

The world's most advanced rebound hammer, with unmatched dispersion characteristics, durability and measuring range. Independent validation testing by BAM Germany has shown that the SilverSchmidt's patented measuring principle has less dispersion than the classical hammers over the entire range. Its inherent impact angle independence removes one possible source of user error completely. Automatic evaluation according to pre-defined statistical criteria and software analysis tools, greatly enhance the uniformity assessment application. All major standards recommend to create mixtures specific curves. Such user defined correlation curves can be downloaded via the powerful Hammerlink software (PC version only) onto the hammer. This, together with on board correction for form factor and carbonation allows the best possible assessment of compressive strength.

SilverSchmidt complies fully with :
EN 12504-2 and EN 13791.

The following standards have been applied in SilverSchmidt for the procedure to determine the rebound number: ASTM C805, JGJ/T 23-2011.

SilverSchmidt ST Type N
SilverSchmidt ST Type L
SilverSchmidt PC Type N
SilverSchmidt PC Type L

Rebound Concrete Test Hammers: C380

STANDARDS: EN 12504: Part 2 / ASTM C805 / UNI 9189 / DIN 1048

BS 1881:202 / NF P18-417 / UNE 83307

Designed to perform non-destructive tests on concrete structures, it gives an immediate indication of the compressive strength of the concrete using the calibration curve supplied with. MODELS: C380

Concrete test hammer, Matest model

Spring impact energy 0,225 mkg. (2,207 Joule or Nm)

Suitable for finished concrete structures and buildings having strength resistances from 10 to 70 N/sq.mm.

This concrete test hammer, entirely produced by Matest, has aluminium frame, and thanks to its very accurate manufacture processing and selected components ensures high precision test results in the time.

The top quality test hammer available on the market.

Supplied complete with calibration curve chart in N/mm² (Mpa) values, abrasive stone, carrying case.

Dimensions with the case: 330x100x100 mm

Concrete test hammer, Matest model: C381

Similar to mod. C380, but with impact energy of 0,735 Joule (Nm). Ideal to test small sized, sensitive and thin walled materials.

Suitable to test also rock core samples.

Anvil: C390

STANDARD: EN 12504:2

Used for the verification of the calibration of the concrete test hammers. Special steel alloy made.

Dimensions: dia. 150 by 320 mm.

Weight: 16 kg

NOTE:

The EN 12504:2 Specification requires obligatory the use of the anvil for the hammer tests. The Standard specifies:

- Before a sequence of tests on a concrete surface, take and record readings using the steel reference anvil and check to ensure that they are within the range recommended by the manufacturer. If they are not, clean and/or adjust the hammer.

- After tests, take readings using the steel anvil, record them and compare them with those taken prior to the test. If the results differ, clean and/or adjust the hammer and repeat the test.

Ultrasonic Pulse Velocity Series



Pundit Lab(+)

The Pundit Lab is a flexible UPV test instrument designed primarily for operation in laboratories. It supports all traditional UPV test modes. The Pundit Lab+ comes with an extended feature set.

Consists of:

display unit, 2 transducers (54kHz), 2 BNC cables 1.5 m, couplant, calibration rod, battery charger with USB-cable, 4x AA(LR6) batteries, data carrier with software, documentation and carrying case.

Pundit 250 Array

The Pundit 250 Array deep imaging scanner is perfect for thickness measurements, localization of defects and detection of objects in concrete and fibre reinforced concrete. It features real-time B-Scans and a panorama mode.

Consists of: Pundit Touchscreen,

Pundit Array transducer, Pundit 250 Array software, Pundit Array Cable 12-pin 1.5m, Pundit Array contact tester, 6x Rechargeable AA NiMH batteries, power supply, USB cable, calibrated tape, DVD with software, documentation, carrying strap and carrying case.

Pundit 200 Pulse Echo

The Pundit 200 Pulse Echo extends the ultrasonic application to objects where access is restricted to a single side. Major applications are slab thickness measurements and the location of voids and delaminations. Rugged touchscreen with intuitive user interface.

Pundit 200

The Pundit 200 is a best-in-class UPV test instrument with an extended range of measurement modes. Rugged touchscreen with intuitive user interface for best possible measuring and analysis of the measured data.

Standardization : EN 12504-4 , ASTM C 597-02 , ISO 1920-7:2004 , IS 13311, CECS 21

	Pundit Lab(+)	Pundit 200	Pundit 200 Pulse Echo	Pundit 250 Array
Measuring Range Depending on Concrete quality	Up to 15 m	Up to 15 m	Up to 1 m	Up to 1 m
Bandwidth	20 to 500 kHz	20 to 500 kHz	20 to 500 kHz	15 to 100 kHz
Measuring Resolution	0.1 us	0.1 us	0.1 us	1 µs
Pulse Voltage UPV	125 to 500 V	100 to 450 Vpp	-	-
Pulse Voltage UPE	-	-	± 50 to ± 200 V	±150 V
Receiver Gain	1x, 10x, 100x, AUTO, Pundit Lab+ up to 1000x	1 to 10'000x (0 to 80 dB)	1 to 10'000x (0 to 80 dB)	1 to 10'000x (0 to 80 dB)
Nominal transducer frequency	24 – 500 kHz	24 – 500 kHz	24 – 500 kHz	50 kHz shear wave
Pulse Shape	Square Wave			
Display	79 x 21 mm passive matrix OLED	7" color rugged touchscreen unit (800 x 480) pixels with dual core processor		
Memory	> 500 measured values	Internal 8 GB flash memory		
Battery	Mains/Battery(>20h)	Lithium Polymer, 3.6 V, 14.0 Ah > 8h (in standard operating mode)		

Ultrasonic Pulse Velocity Testers



C369N

Ultrasonic Pulse Velocity Testers: C369N

STANDARDS: EN 12504 part. 4 / ASTM C597 / BS 1881:203 / UNI 9524 / NF P18-418 / UNE 83308

Used to determine the presence of faults, voids, cracks etc., in in-situ or precast concrete and for longterm monitoring of structures subject to environmental conditions. They give data concerning the homogeneity of the concrete, by generating pulses of sound into the concrete and measuring the time the sound to travel from the transmitter probe to the receiver probe through the material. Furthermore it is possible to have indicative data about the modulus of dynamic elasticity, and strength of the concrete.

Ultrasonic pulse velocity tester "high technology":

- Measuring range: 0 - 3000 μ s - accuracy +/- 0,1 μ s
- Selection of the ultrasonic pulse amplitude adjustable from 250 to 1000 V
- Measurement of the required time by the ultrasonic pulse to go through the tested material.
- Single or continuous acquisition mode with automatic or manual saving.
- Zero calibration with depuration of the time for the pulse to go through the probes.
- Calibration of a defined time value.
- Capacity of data acquisition, processing and filing of the test data up to 30.000 samples.
- Interface mini USB for PC connection.
- Two outlets for connection to the oscilloscope.
- Languages: English, French, German, Spanish, Italian.
- The use of the instrument is made easy because it is based on the user-friendly system.

The standard appliance includes:

- The instrument in basic configuration in a practical palmer container.
- Two 55kHz probes with connection cables.
- Calibrating cylinder and contact paste.
- Battery rechargeable pack NiMh 4,8V > 2000m/A with low battery condition alarm.
- Anti shock case holding the unit and the accessories.
- External feeder 230V and battery charger 12V 500m/A.

Rebar Locator Series



Profoscope(+)



Zircon MT 6

Profoscope(+)

Handy cover meter with integrated display and assisted detection feature. Profoscope+ includes all Profoscope features plus internal memory+ available for storing measured covers and diameters.

Cover Measuring Range	Up to 185 mm
Cover Measuring Accuracy	\pm 1 to 4 mm, depending on cover
Diameter Measuring Range	Up to 63 mm
Diameter Measuring Accuracy	\pm 1 rebar size
Power source	2 x 1.5 V AA (LR6) batteries

Consisting of:

Profoscope+ incl. start-up test kit and accessories (batteries, memory card, USB-cable, canvas bag, carrying strap, chalk, documentation, ProfoLink software)

Zircon MT 6 Rebar Locator: MT 6

Locate embedded metal before your drill bit or saw blade does. MT 6 is the tool you need if you are sawing concrete slabs or walls that contain rebar, conduit, or plumbing. This powerful dedicated metal scanning tool can locate metal up to 6 inches (152 mm) deep in solid concrete.

MT 6 locates both ferrous and non-ferrous metal up to 6 inches deep in concrete and other non-metallic surfaces. It also differentiates between ferrous and non-ferrous metal targets and indicates the target depth in inches and centimeters.

MT 6 to find or avoid rebar, cables, pipe, nails in reclaimed wood, nails/tacks in studs behind lath & plaster walls, electrical boxes and conduit, and more.

-Automatically differentiates between magnetic metal (such as rebar) and non-magnetic metal (such as copper pipe)

-Shows the depth of metal from the surface in both inches and centimeters

-Easy-to-read LCD screen identifies the location of metal objects to the nearest inch and depth to the nearest 1/2 inch (13 mm)

-Helps map out the grid of metal through any nonmetallic construction material, including concrete, tile, and marble

Profometer Series



Profometer Corrosion

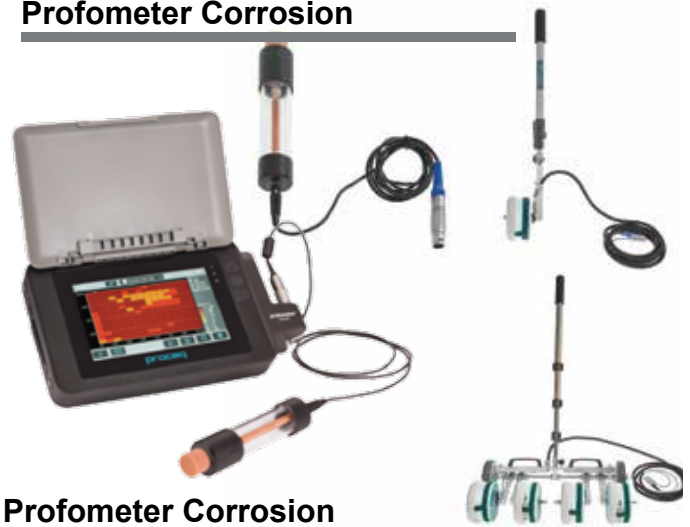

Profometer Series

Profometer 6 are advanced cover meters for the precise and non destructive measurement of concrete cover, rebar diameters and the detection of rebar locations using the eddy current pulse induction principle as the measuring method.

Based on the new generation Profometer touchscreen, the instrument offers real time control over the measurement procedure directly on site. The high resolution color display allows best possible data collection, evaluation and analysis for an entire working day. The flexible concept allows to upgrade anytime between cover meter and corrosion analysis instruments.

Specification for Profometer series

- Cover Measuring Range Up to 185 mm
- Cover Measuring Accuracy ± 1 to 4 mm depending on cover
- Diameter Measuring Range Up to 63 mm
- Diameter Measuring Accuracy ± 1 rebar size

Standards: BS 1881, Part 204., DIN 1045 DGZfP B2. SN 505262. , SS 78-B4.

Profometer Corrosion

The corrosion of the reinforcing steel is the primary cause of deterioration of reinforced elements. The mapping of the electrical potential as measured on the surface of the concrete allows the detection of the spots with increased corrosion likelihood and represents a primary tool for the maintenance and for the structural assessment of a concrete structure.

As the direct successor to the Canin+, the Profometer Corrosion represents the most advanced corrosion instrument in the market. With the flexible concept, the user can upgrade anytime to the Profometer 6 Cover Meter functionalities.

- Standards: ASTM C 876-09
- RILEM TC 154-EMC
- DGZfP B3
- SIA 2006
- UNI 10174
- JGJ/T 152
- JSCE E 601

Profometer 6 Cover Meters

Profometer 600



Profometer 630 AI



Profometer 650 AI



Profometer Corrosion



For safe drilling, coring and cutting, conformity check of concrete cover, fire resistance assessment and rebar assessment on unknown structures

For corrosion analysis

Rebar Location				
Cover Measurement				
Diameter Estimation				①
1-Layer NRC				
2-Layer AI				
Cover Calibration				
Single-Line Scan	③			① + ③
Multi-Line Scan				
Area Scan				
Cross-Line Scan	③	③		① + ③
Corrosion Potential	②	②	②	

Functionality

① ② Upgrade kits available (attachable hardware)

③ Software upgrades available (activation key)

XCell , Corrosion



XCell

Giatec XCell™ is a smart tablet-based NDT probe for fast, accurate and efficient detection and on-site analysis of corrosion in reinforced concrete structures. Giatec XCell™ meets all the requirements of the ASTM C876 standard specification.

Giatec XCell™ benefits from an advanced Bluetooth-enabled maintenance-free sensor that measures the corrosion potential and sends it wirelessly to a tablet for generating half-cell contour plots (i.e. corrosion maps) in real-time. The results can be shared easily with the engineering office. Giatec XCell™ significantly reduces the labor cost associated with the data collection and subsequent contour plot generation and reporting.

Giatec XCell™ can be used for efficient and accurate corrosion mapping according to the ASTM C876, "Standard Test Method for Half-Cell Potentials of Uncoated Reinforcing Steel in Concrete". The results are analyzed using the Android-based application onsite for the identification of locations with high probability of corrosion.

Specifications:

Voltage Measurement Range	± 1,000 mV
Measurement Resolution	0.1 mV
Sampling Rate	1 s
Input Impedance	>10 M ohm
Temperature Measurement Range	-10 ~ 50 °C
Temperature Measurement Accuracy	0.5 °C
Communication Protocol Standard	Bluetooth V4.0 LE
-ASTM C876 Standard Test Method for Half-Cell Potentials of Uncoated Reinforcing Steel in Concrete.	
-RILEM TC 154	
-UNI 10174	
-DGZfP B3	
-vSIA 2006	
-BS 1881, Part 201	

Resipod , Resistivity



Resipod

Concrete surface resistivity meter

Surface resistivity measurement provides extremely useful information about the state of a concrete structure. Not only has it been proven to be directly linked to the likelihood of corrosion and the corrosion rate, recent studies have shown that there is a direct correlation between resistivity and chloride diffusion rate. The versatility of the method can be seen in these example applications:

- Estimation of the likelihood of corrosion
- Indication of corrosion rate
- Correlation to chloride permeability
- On site assessment of curing efficiency
- Determination of zonal requirements for cathodic protection systems
- Identification of wet and dry areas in a concrete structure
- Indication of variations in the water/cement ratios within a concrete structure
- Identification of areas within a structure most susceptible to chloride penetration
- Correlation to water permeability of rock

Resipod is a fully integrated 4-point Wenner probe, designed to measure the electrical resistivity of concrete in a completely non-destructive test. It is the most accurate instrument available, extremely fast and stable and packaged in a robust, waterproof housing designed to operate in a demanding site environment.

Specifications:

Range	0.1 – ca. 1000 kΩcm
Resolution, 200μA	±0.2 kΩcm or ±1%
Resolution, 50μA	±0.3 kΩcm or ±2%
Resolution, <50μA	±2 kΩcm or ±5%
Frequency	40 Hz
Memory	500 measured values
Power	>50 hours autonomy
Charger	USB type B, (5V, 100mA)

Standard:

AASHTO T358-15

Resipod Resistivity Meter, 1.5" (38mm)

Resipod Resistivity Meter, 2" (50mm)

Resistivity and Permeability



RCON2™ is the most easy-to-use multifunctional concrete electrical resistivity device.

Giatic Perma2™ is a laboratory test device for measuring the resistance of concrete against chloride penetration. Perma2™ complies with ASTM C1202 (RCPT), AASHTO T277 and ASTM C1760 standards. The measurements can be used to estimate the chloride diffusion coefficient of concrete for service life prediction, durability-based design and quality control of concrete materials and structures.

Perma2™
Rapid Chloride Permeability Test



Surf™
Surface Electrical Resistivity

Surf™ | Concrete Surface Resistivity

Giatic Surf™ is a laboratory test device for rapid, easy and accurate measurement of the surface electrical resistivity of concrete based on the four-probe (Wenner-Array) technique. The Surf™ patented technology automatically measures resistivity around the concrete specimen using four channels of 4-probe array (located at 90° from each other). The PC software generates the required reports according to the standard specifications.

Surf™ can be used to determine the chloride permeability of concrete in accordance with AASHTO TP95 and the upcoming ASTM standard. The measurement data can be used for durability-based quality control of concrete as well as the service life design of concrete structures.

Frequency 13 – 100 Hz
Measurement Channels 4

Reading Range	Frequency range	Accuracy
0.1 – 100 KΩ.cm	13 – 100 Hz	± (0.1+1%)
100 – 1000 KΩ.cm	13 – 100 Hz	± (1+1%)

Perma2™ | Rapid Chloride Permeability

Giatic Perma2™ is a completely re-engineered laboratory test device for the measurement of the electrical resistance of concrete against the penetration of chloride (RCPT) according to the standard methods such as ASTM C1202, AASHTO T277 and ASTM C1760. The measurement data can be used to estimate the chloride diffusion coefficient of concrete for the service life prediction and design of concrete structures as well as the durability-based quality control of concrete.

Perma2™ is electrically certified for rapid chloride penetrability test in concrete laboratories and its measuring cell sizes are according to the ASTM and AASHTO specifications. Equipped with a verification kit, Perma2™ is an accurate test device for concrete labs.

Applied Voltage	60 ± 0.1 V
Range of current measurement	0 ~ 500 mA ± 0.1 mA
Temperature measurement range	0 ~ 100°C
Measurement channels	4

RCON2™ | Concrete Bulk Resistivity

Giatic RCON2™ is a non-destructive device for measuring the electrical resistivity of concrete specimens in the laboratory without any additional sample preparation requirements. This measurement can easily be made on the same concrete samples that are currently used for the compressive strength testing of concrete.

RCON2™ is fast (measurement time is less than 5 seconds), accurate (utilizing variable frequency method) and flexible (the measurement can be taken with different settings for verification). RCON2™ also allows for continuous measurement of electrical resistivity over time, which can be used to monitor several other parameters such as cracking, moisture transfer and time of setting in concrete specimens.

Reading Range	Frequency spectrum	Phase measurement	Impedance accuracy	Phase accuracy
1 ~ 100 Ω	1Hz ~ 30KHz	0 ~ 180°	± 2% ± 2digit	5 % ± 3digit
100Ω~1000Ω				
1 ~ 10 KΩ	1Hz ~ 10KHz			
10 ~ 100 KΩ				
100 KΩ ~ 1 MΩ				

Pull-Off Testers



Fully automated pull-off testers

EN 1542 ,EN 1015-12,EN 1348,ISO 4624, ASTM D 4541, ASTM C 1583,ASTM D 7234,ASTM D 7522,

ZTV-ING,SIA 281/3,JGJ 110,JGJ 126,JGJ 144

Pull-off testing is one of the most widely used test methods in the construction industry. This is reflected in the huge number of standards dedicated to the method.

It has long been known that one of the major influences on the result of a pull-off test is the operator influence in the application of a constant load rate. The DY-2 with its integrated, feedback controlled motor removes this variable completely, by providing a fully automated test at a constant load rate which can be verified.

The DY-2 is further unique in that it records every single test parameter required by the specification.

- Time and date of the test
- Test disc size
- Maximum load applied
- Automatic calculation of bond strength
- Applied load rate with graphical record
- Complete time of test
- Failure mode

For the very first time, the operator is able to provide a complete record of the pull-off test, proving that the test was carried out in accordance with the applicable standard.

	Tensile Force	Test Disc Ø 50mm
DY-206	0.6 - 6 kN 135 - 1349 lbf	0.3 - 3.1 MPa 44 - 443 psi
DY-216	1.6 - 15.5 kN 360 - 3485 lbf	0.81 - 7.8 MPa 118 - 1145 psi
DY-225	2.5 - 25 kN 562 - 5620 lbf	1.3 - 12.7 MPa 185 - 1847 psi

SmartBox



Giatic SmartBox

Giatic SmartBox™ is a compact wireless device for the measurement and monitoring of electrical resistance and temperature in fresh concrete. The continuous measurements are recorded on SmartBox™ and can be downloaded using the mobile application on Android smart-phone/tablet.

The electrical resistivity of fresh concrete has been shown to provide a good indication on the water content as well as setting and hardening of concrete. SmartBox™ provides an efficient tool for various research studies in these areas.

Reading Range	1 – 3000 Ω
Measurement Frequency	10 kHz
Accuracy	± 2%
Measurement Time	<1 s

SmartRock2



SmartRock2

SmartRock2™ is a rugged waterproof wireless sensor that allows real-time temperature and maturity monitoring of concrete. The sensor is placed in the concrete formwork (installed on the rebar) before pouring. Using the SmartRock2™ app you can view the temperature and resulting concrete strength in real-time.

- Wireless Sensor Technology up to 6-8meters
- Easy data sharing
- Rugged and waterproof
- Android and iOS
- Real-time temperature & strengthb
- Long battery life (~4 months)
- Reading range -30 to 90c
- Accuracy +/-1%
- Measurement Frequency
Once every 30mins for 1month

L-Shape Box



T-15000

V-Funnel



T-15020

U-Shape Box



T-15010

Cutting Machine



T-15100

L-Shape Box: T-15000

Determination of confined flowability and passability. The L shape box made of stainless steel , it has a slide gate.

Includes 2 different obstacles.

- 12mm. dia. x 2 bars , 59mm. gaps.
- 12mm. dia. x 3 bars , 41mm. gaps.

U-Shape Box: T-15010

Determination of confined flowability of self consolidating concrete. Made of Stainless Steel.

V-Funnel: T-15020

Determination of self consolidating concrete through the flowing speed from a funnel. Made of Stainless Steel. Bucket not included.

Cutting Machine: T-15100

For use with concrete specimens. This machine complete with a diamond blade. It is fitted with a pedal controlling the movement of the head with protection for the blade and with Mechanical plunger pump for cooling water circulation.

Motor: 3hp.

Power: 380v 3ph.

general



General Section:

Product	page	Product	page
Drying Oven.....	49	Round Bowls.....	53
Dial Gauge.....	50	Trowel.....	53
Proving Ring.....	50	Wire Brush.....	53
GT100R Metal Thermometer.....	50	Brush.....	53
PT-50R Thermometer.....	50	Chisels.....	53
Vernier Caliper.....	50	Ladle.....	53
Mechanicals Balance		Evaporation Mixing Dish.....	54
- Triple Beam.....	51	Volumetric Flasks.....	54
- Heavy Duty Solution	51	Wash Bottle.....	54
- Cent-O-Gram.....	51	Laboratory Bottle.....	54
- Field Test Scale.....	51	Specific Gravity Flask (Le Chatelier).....	54
Digital Balance Series		Graduated Cylinder, Glass.....	54
- Renger2000.....	52	Graduated Cylinder, Plastic.....	54
- Defender 3000 Series	52	Beaker, Glass.....	54
- AJ Series.....	52	Beaker, Plastic.....	54
Scoop.....	53	Core Drilling Machine	
Square Pan.....	53	- Electric Diamond Core Drill.....	55
Aluminum Can.....	53	- Engine Diamond Core Drill.....	55
Rubber Mallet.....	53	Trichloroethylene.....	55
Spatula.....	53	Diamond Core Bit.....	56
Hammer.....	53	Diamond Saw Blade.....	56
Stainless steel Pan.....	53		

Drying Oven



Drying Oven

The most simple oven with high accuracy and high efficiency. Special function key for temperature setting and time setting. Chamber made of stainless steel.

Model	WHL-0B	101-AB	WHL125B	WGLL125BE(Fan)	WGLL230BE	WGL625B
Temp Variation	RT+10-250°C					
Temp Fluctuation	±5.0°C					
Volume	39L	64.8L	123L	123L	225L	627L
Voltage	220V 50Hz.					
Chamber size(mm)	350x350x350	400x360x450	500x450x550	500x450x550	600x500x750	660x760x1250
Shelf	2	2	2	2	2	2

Drying Oven

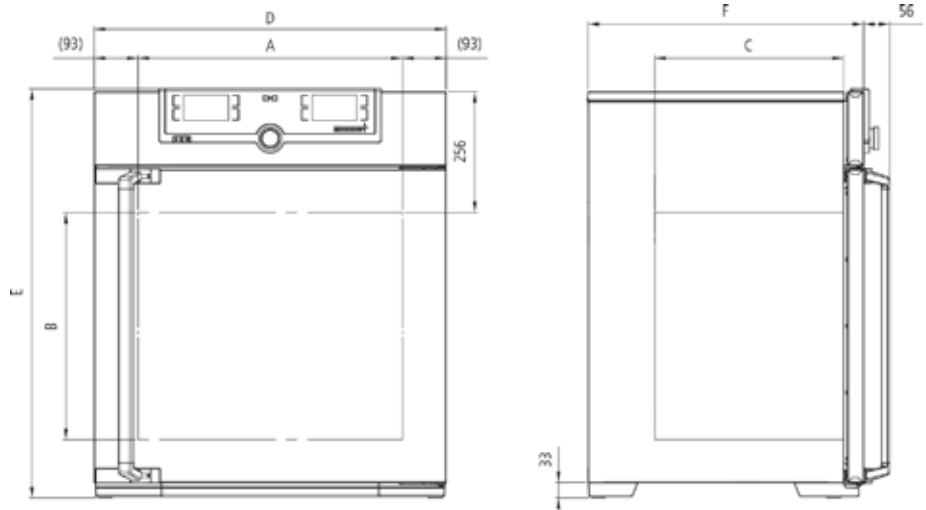

Model sizes/Description			30	55	75	110	160
Stainless steel interior	Volume	approx. l	32	53	74	108	161
	Width (A)	mm	400	400	400	560	560
	Height (B)	mm	320	400	560	480	720
	Depth (C)	mm	250	330	330	400	400
	Stainless steel grids (standard equipment)	number	1	1	2	2	2
	Max. number of grids	number	3	4	6	5	8
	Max. loading per grid	kg	30				
	Max. loading of chamber	kg	60	80	120	175	210
Further data	Electrical load at 230 V, 50/60 Hz	approx. W	1600	2000	2500	2800	3200
	Working-temperature range	°C	at least 5K above ambient temperature to +80				
	Setting temperature range	°C	+20 to +80				
	Setting accuracy	K	0.1				

Dial Gauge



T-16000



KI-121



KM-130

Proving Ring



T-16002



T-16006



T-16010

Proving Ring

- Proving ring 2,000 lbs.with dial gauge: T-16002
- Proving ring 6,000 lbs.with dial gauge: T-16006
- Proving ring 10,000 lbs.with dial gauge: T-16010

Dial gauge for proving ring

Dial Indicator is surely utilized at manufacturing sites where dimensional high accuracy is needed to be confirmed. The dial indicator is applied for direct measurement to measure actual dimension and comparative measurement for measuring displacement volume from a certain standard dimension.

Model	KM-130
Graduation (mm)	0.01
Measuring Range (mm)	30
Weight (g)	200

Model	KI-121
Graduation (inch)	0.001"
Total Range (inch)	1.0
Weight (g)	115

Dial gauge for proving ring

Model	T-16000
Graduation (inch)	0.0001"
Stroke (inch)	0.5
Weight (g)	200

Thermometers Series



0110-00,
0290-00



PT-50R
(Standard dial,
with 1" dial)



GT100R
(With 1 1/2" dial)



Laboratory Testing and General Purpose Bimetal Thermometers

These models are used for general-purpose testing applications such as laboratory, concrete, asphalt, soil and OEM equipment.

- GT100R Metal Thermometer: 50/500FC
- GT100R Metal Thermometer: -40/70C
- GT100R Metal Thermometer: -10/110C

1" Testing and Spot Checking Thermometers

A pocket sized thermometer used by inspectors, service and maintenance personnel, and technicians for general checking in food service, refrigeration, air conditioning, hot asphalt and food processing applications. Often modified for OEMs to use in limited space situations.

- Thermometer 0/300C: PT-50R

Thermometer: SATO/Japan

Model	Range	Length (cm)	Liquid
0110-00	0 to 100°C	30	Red liquid
0290-00	0 to 200°C	30	Red liquid

Vernier Caliper

A long caliper is very convenient for its user friendliness but does require some care in use. In the first place it is important to realize there is no relationship between resolution and accuracy

Type	Range
Vernier Range	8" , 12"
Digital Vernier	8" , 12"

Mechanicals Balance



Cent-O-Gram



Triple Beam



Field Test Scale



Heavy Duty Solution

Triple Beam

The OHAUS Triple Beam continues to set the standard for accuracy and durability for mechanical balances. The Triple Beam is recognized around the world as the number one mechanical balance for precise weight determination and long-term use.

- Pan Size: 6 in (152 mm)
- Capacity: 2610g.
- Readability: 0.1g.
- Net Weight: 2.1 kg

Heavy Duty Solution

The heavy duty solution balance has set an industry standard for precision in high capacity weighing. Although strongly built to resist corrosion and shrug off harsh environments it reads with a feather touch down to 1g. over the whole weighing range. It has a large, unobstructed stainless-steel platform and a lockable tare for containers. Readings are taken from the two sliding weight beams and a set of slotted weights, which are provided with the balance and stored in the base.

Durable enough to resist corrosion, this precise balance also weighs with a feather touch, down to 1 g over the whole weighing range - even under the most demanding conditions.

- Pan Size: 11 in
- Capacity: 20 kg.
- Readability: 1g.
- Net Weight: 19 kg

Cent-O-Gram

The Cent-O-Gram and Dial-O-Gram balances offer the accuracy and convenience of an integrated weigh below balance while allowing students to visualize mass measurement principles. Designed with a hanging pan system, both balances offer 10 times the readability of the Ohaus Triple Beam and Dial-O-Gram top loading balances

- Pan Size: 0.5 in x 3.5 in (13 mm x 89 mm)
- Capacity: 311g.
- Readability: 0.01g.
- Net Weight: 1.6 kg

Field Test Scale

The Field Test Scale provides accurate weighing of a wide variety of heavy materials, even under the most adverse conditions. The Field Test Scale is ruggedly built and designed for field applications where accurate measurements are essential.

- Platform Size: 10 in
- Capacity: 16kg.
- Readability: 5g.
- Net Weight 8.4 kg

Digital Balance Series



Renger2000



Navigator



Pioneer Series

Digital Balance Chart

Capacity	Readability	Model	Mfg.series	Power	Platform size	Ship.Wt.
3kg	0.1g	R21PE3	Renger2000	AC/Recharge	300 × 225 mm	5.15kg
15kg	0.5g	R21PE15	Renger2000	AC/Recharge	300 × 225 mm	5.15kg
30kg	1g	R21PE30	Renger2000	AC/Recharge	300 × 225 mm	5.15kg
2100g	0.1g	NVL2101/2	NavigatorXL	AC/Recharge	194 x 203 mm	2.8kg
20000g	1g	NVL20000/2	NavigatorXL	AC/Recharge	194 x 203 mm	2.8kg
4100g	0.01g	PA4201	PioneerSeries	AC/Recharge	18cm dia.	4.5kg

The OHAUS Defender 3000 Series

line of bench scales is ideal for general weighing and simple counting applications in production, packaging, warehouse, inventory, shipping and receiving areas. The Defender 3000 Series features a simple, yet rugged tubular-frame base design and indicators with tactile keys, backlit LCD display, built-in rechargeable battery operation and flexible mounting capabilities



D31P60BR

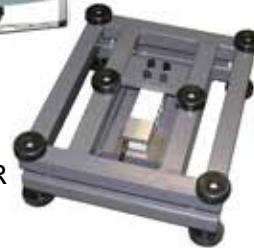

Defender 3000



Model:	D31P30BR	D31P60BR	D31P60BL	D31P150BL	D31P150BX	D31P300BX
Capacity	30kg x 5g	60kg x 10g	60kg x 10g	150kg x 20g	150kg x 20g	300kg. x 50g
WxDxH(mm)	305x355x123		420x550x136		500x650x143	
Weighing Unit	kg, lb, g, oz, lb:oz					
Power	AC adapter with internal rechargeable lead acid battery					

AJ Series

All mighty weighing system



AJ Series

SIMPLE IS THE BEST. This is the basic concept of ViBRAAJ series. Simple, but profound scope for wide measurement fields. Laboratory, factory, jewelry shops, etc. ViBRAAJ series is always the simplest & the best solution for your needs.

Large LCD (16.5mm height approx) with blight & white back-light makes the weighing operation easy. Calibraiton with built-in weight

Capacity	Readability	Model	Mfg.series	Power	Platform size	Ship.Wt.
6200g	0.1g	AJ6200E	AJ series	AC4	180x160mm	2.8kg

General Equipment



T-20002



T-20140.1



T-20050



T-20200.26



T-20011.4



T-20012



T-20051.1



T-20210.15



T-2000C.2



T-20010

T-20054



T-20052.2



T-21818

T-22424

Scoop

Cast Iron materials, for general purpose. Round bottom

- Small size: T-20001
- Medium size: T-20002
- Large size: T-20003

Square Pan

Galvanized steel with wire-bound, rolled-top edges with handles to carry.

- Galvanized steel 18"x 18"x3": T-21818
- Galvanized steel 24"x 24"x3": T-22424

Aluminum Can

Made of Aluminum, flat bottom and straight side comes with the tight cover on the top. The sample is protected during testing weighing and drying.

- Can 3oz 2" (54x35mm.): T-2000C.2
- Can 4oz 2.5" (60x44mm.): T-2000C.2.5
- Can 6oz 3" (70x48mm.): T-2000C.3

Rubber Mallet: T-20010

For a softer blow with wooden handle.

Spatula

Stainless steel blade with Wooden handle.

- 4" Length: T-20011.4
- 6" Length: T-20011.6

Glove: T-20140.1

For best protection from heat, cold and chemical.

Stainless steel Pan

Stainless steel pan

- 26 x 42.5 x 5cm: T-20200.26
- 30 x 40 x 5cm: T-20200.30

Round Bowls

Stainless steel round bowl.

- 15cm diameter.: T-20210.15
- 25cm diameter.: T-20210.25
- 30cm diameter.: T-20210.30

Trowel: T-20050

Wooden handle good grip for mixing cement, has a flat blade.

Wire Brush: T-20051.1

Wire Brush with wooden handle. Used for cleaning

Brush

Soft Brush with wooden handle. Used for cleaning

- Soft Brush 1": T-20052.1
- Soft Brush 2": T-20052.2

Ladle: T-20054

A ladle used for Yellow sulphate to pour in a vertical capper and also for other material.

Hammer: T-20012

The hammer is a tool that delivers a blow break apart objects or other material. A head made of steel

Volumetric Flasks**Le Chatelier**

H-3400

H-3393

Wash Bottle**Laboratory Bottle****Evaporation Mixing Dish****Graduated Beaker Plastic****Graduated Cylinder Plastic****Graduated Cylinder Glass****Wash Bottle**

Capacity 500ml. T-20150

Laboratory Bottle: T-20151

Capacity 500ml.

Evaporation Mixing Dish

made of porcelain, suitable for mixing a material.

Model	T-20100.77	T-20100.10	T-20100.13
Dia.	77mm	100mm	113mm

Volumetric Flasks

ASTM D854; AASHTO T100

Glass flasks used in specific gravity determinations are calibrated to contain the rated capacity at 20°C within permissible tolerances. Available with and without a stopper

Capacity	Model
100ml Volumetric Flask	H-3391
250ml Volumetric Flask	H-3392
250ml Volumetric Flask with Stopper	H-3393
500ml Volumetric Flask	H-3394
500ml Volumetric Flask with Stopper	H-3395

Graduated Cylinder, Glass

Capacity	Model
50ml	T-21005
100ml	T-21010
250ml	T-21025
500ml	T-21500
1000ml	T-21100
2000ml	T-21200

Graduated Cylinder, Plastic

Capacity	Model
50ml	T-22005
100ml	T-22010
250ml	T-22025
500ml	T-22500
1000ml	T-22100
2000ml	T-22200

Specific Gravity Flask (Le Chatelier): H-3400

ASTM C128, C188; AASHTO T133

For determining the specific gravity of hydraulic cement, dust, sand and other fine materials. The body holds approximately 250ml. The oval bulb in the neck holds 17ml. Volume below the bulb is graduated from 0 to 1.0ml in 0.1ml subdivisions, with an additional 0.1 subdivision below the 0 and above the 1.0ml mark. The neck is graduated from 18 to 24ml in 0.1ml subdivisions above the bulb (white graduations). The stopper is a number 13.

Beaker, Glass

Capacity	Model
50ml	T-23005
100ml	T-23010
250ml	T-23025
400ml	T-23040
600ml	T-23060
1000ml	T-23100

Beaker, Plastic

Capacity	Model
50ml	T-24005
100ml	T-24010
250ml	T-24025
400ml	T-24040
600ml	T-24060
1000ml	T-24100

Engine Diamond Core Drill

T-25000



Electric Diamond Core Drill

SCY-2550



Trichloroethylene



Rectangular Can
T-28020



200 liter Tank
T-28200

Engine Diamond Core Drill: T-25000

For vertical drilling only, machine can be carried in pick up or van as needed. Effortless ball screw feed operates at convenient height. Designed for easy use by one operator.

Requires water supply. Includes one diamond core bit.

- Engine: 5hp, Gasoline.

Trichloroethylene

Available:

- **Rectangular Can 20kg:** T-28020
- **200 liter tank:** T-28200

The solvent for extract premixed sample (Separates Asphalt Cement from Aggregate)

Electric Diamond Core Drill: SCY-2550

The core drill can be adjusted and can drill inclined holes from 0-45°. Light and easy for transportation and installation drill frame tight and equipped with wheels.

The frame with general fast connecting block and suitable for the majority of products on the market base, frame, the bracket and all adjusting screw can be used with the pushing handle attached to adjust.

Safety Clutch and Overload Protection.

Water proof switch .

Soft-starting.

Gear speed-regulation.

Specification:

Concrete drilling range	upto 10"
Rated voltage	220v
Rated frequency	50-60
Rated Input power	4350
No-load speed	100-400/800

CUT & CORE

Diamondtools

Diamond Core Bit



Diamond Core Bit

Premium quality core bits provide smooth and clear drilling. Assembly diamond core bit is made up of drilling head, Application for Heavy Reinforced Concrete , Standard Concrete and Brick.

Black color for Asphalt.

Orange color for Concrete.

Diameter x Length	Model	
	concrete	asphalt
25mm x 410mm.	T-26025C	T-26025A
32mm x 410mm.	T-26032C	T-26032A
38mm x 410mm.	T-26038C	T-26038A
51mm x 410mm.	T-26051C	T-26051A
63mm x 410mm.	T-26063C	T-26063A
76mm x 410mm.	T-26076C	T-26076A
102mm x 450mm.	T-26102C	T-26102A
126mm x 450mm.	T-26126C	T-26126A
152mm x 450mm.	T-26152C	T-26152A
160mm x 450mm.	T-26160C	T-26160A
180mm x 450mm.	T-26180C	T-26180A
203mm x 450mm.	T-26203C	T-26203A
254mm x 450mm.	T-26254C	T-26254A
300mm x 450mm.	T-26300C	T-26300A

Diamond Saw Blade



For cutting Asphalt Concrete and abrasive material. Our diamond blade are made of good metal bond with high quality diamond grit. Suitable for free cutting and dry cutting on general purpose material, Asphalt and Concrete

Diameter	Model	
	concrete	asphalt
14"	T-27014C	T-27014A
18"	T-27018C	T-27018A



Model	Page	Model	Page
0110-00.....	50	R21PE15.....	52
0290-00.....	50	R21PE3.....	52
101-AB.....	49	R21PE30.....	52
AJ6200E.....	52	SCY-2550.....	55
C369N.....	42	SD-II.....	20
C380.....	40	SLF-400.....	14
C381.....	40	SLF-400.F.....	14
C390.....	40	SY-1.5C.....	15
Cent O Gram.....	50	T-1000.....	5
CXS-2806.....	14	T-1002.....	5
CXYAW-300S.....	23	T-1003.....	5
D31P150BL.....	52	T-1003P.....	5
D31P150BX.....	52	T-1003S.375.....	5
D31P300BX.....	52	T-1003S.4.....	5
D31P30BR.....	52	T-1003S.500.....	5
D31P60BL.....	52	T-1003S.750.....	5
D31P60BR.....	52	T-1003S1.....	5
DB-4B.....	14	T-1003S1.5.....	5
E044N.....	28	T-1003S2.....	5
GT100R.....	50	T-10100.....	24
H-1344.....	13	T-10110.....	24
H-2783.....	38	T-10120.....	26
H-2786P.....	38	T-10228.....	26
H-3049.....	28	T-10446.....	26
H-3050.....	28	T-10775.....	26
H-3080.....	28	T-10776.....	26
H-3085.....	28	T-11005.....	26
H-3086.....	28	T-11005.2.....	26
H-3150.....	31	T-11005.2.....	26
H-3248.....	29	T-11010.....	26
H-3248D.4F.....	29	T-11010.2.....	26
H-3250.....	29	T-11010.2.....	26
H-3250D.4F.....	29	T-11020.....	26
H-3492A.....	30	T-11020.2.....	26
H-3493A.....	30	T-11020.2.....	26
H-3630A.....	31	T-11200.....	27
H-3810.....	30	T-11201.....	27
H-3820BX.....	27	T-11202.....	27
H-3825BX.....	27	T-11203.1.....	27
H-4133.....	39	T-11203.2.....	27
H-4137.....	39	T-11204.....	27
H-4139.....	20	T-11205.....	27
H-4340.....	20	T-11206.....	27
HHW21.600AI.....	14	T-11207.....	27
L2000.....	20	T-1200L.....	6
MH-II.....	7	T-1200P.....	6
MT6.....	42	T-1200R.1.....	6
NVL20000/2.....	52	T-1200R.2.....	6
NVL2101/2.....	52	T-1200R.375.....	6
PT-50R.....	50		

Model	Page	Model	Page
T-1200R.500.....	6	T-1900C.....	8
T-1200R.750.....	6	T-1900R.....	8
T-121010.....	36	T-2300.....	13
T-121020.....	36	T-23005.....	54
T-121515.....	36	T-1900S.....	8
T-121515H.....	36	T-2000.....	13
T-121530.....	36	T-20001.....	53
T-121560.....	36	T-2000C.2.....	53
T-121575.....	36	T-2000C.2.5.....	53
T-12500.....	36	T-2000C.3.....	53
T-12510.....	36	T-20002.....	53
T-12520.4.....	36	T-20003.....	53
T-12520.6.....	36	T-20010.....	53
T-12530.....	36	T-20011.4.....	53
T-12540.....	36	T-20011.6.....	53
T-1300.....	6	T-20050.....	53
T-13001.....	37	T-20051.1.....	53
T-13002.....	37	T-20052.1.....	53
T-13010.....	37	T-20052.2.....	53
T-13020.....	37	T-2010.....	13
T-13030.....	37	T-20100.10.....	53
T-13100.....	37	T-20100.13.....	53
T-1350.....	6	T-20100.77.....	53
T-1400.12.....	7	T-20140.1.....	53
T-14003.....	37	T-20150.....	54
T-1400P.....	7	T-20151.....	54
T-1401.....	7	T-2020.....	13-18
T-14010.....	37	T-20200.26.....	53
T-14015.....	37	T-20200.30.....	53
T-14030.....	37	T-20210.15.....	53
T-1500.....	7	T-20210.25.....	53
T-15000.....	47	T-20210.30.....	53
T-1501.....	7	T-2100.....	13
T-15010.....	47	T-21005.....	54
T-1502.....	7	T-21010.....	54
T-15020.....	47	T-21025.....	54
T-15100.....	47	T-2110.....	13
T-16000.....	50	T-21100.....	54
T-16002.....	50	T-21200.....	54
T-16006.....	13	T-21500.....	54
T-16006.....	50	T-21818.....	37-53
T-1601.....	7	T-2200.....	13
T-16010.....	50	T-22005.....	54
T-1602.....	7	T-22010.....	54
T-1603.....	7	T-22025.....	54
T-1604.....	7	T-22100.....	54
T-1700.....	8	T-22200.....	54
T-1800.....	8	T-22424.....	53
T-1900.....	8	T-2250.....	13
T-1900.1.....	8		

Model	Page	Model	Page
T-22500.....	54	T-3100.....	14
T-23010.....	54	T-3100F.....	14
T-23025.....	54	T-4000.....	14
T-23040.....	54	T-4100.....	15
T-23060.....	54	T-4200.....	15
T-23100.....	54	T-5000.....	17
T-2350.....	13	T-5010.....	17
T-24005.....	54	T-5020.....	17
T-24010.....	54	T-5030.....	17
T-24025.....	54	T-5100.....	17
T-24040.....	54	T-6000.....	17
T-24060.....	54	T-6001.....	17
T-24100.....	54	T-6002.....	17
T-25000.....	55	T-6516.....	17
T-26025A.....	56	T-7000.....	18
T-26032A.....	56	T-7100.....	18
T-26038A.....	56	T-7200.....	18
T-26051A.....	56	T-7210.F.....	18
T-26063A.....	56	T-7300.....	18
T-26076A.....	56	T-7400.....	18-19
T-26102A.....	56	T-7450.....	18-19
T-26126A.....	56	T-7500.....	18
T-26152A.....	56	T-7502.T2.....	19
T-26160A.....	56	T-7600.....	18
T-26180A.....	56	T-7700.....	18
T-26203A.....	56	T-7800.....	18
T-26254A.....	56	T-7800.....	18-19
T-26300A.....	56	T-8000.....	19
T-26025C.....	56	T-8050.....	19
T-26032C.....	56	T-9000.....	21
T-26038C.....	56	T-9500.....	21
T-26051C.....	56	T-9600.....	22
T-26063C.....	56	T-9700.....	22
T-26076C.....	56	T-C1500.G.....	34
T-26102C.....	56	T-C2000.G.....	34
T-26126C.....	56	WGL625B.....	49
T-26152C.....	56	WGLL125BE.....	49
T-26160C.....	56	WGLL230BE.....	49
T-26180C.....	56	WHL125B.....	49
T-26203C.....	56	WHL-0B.....	49
T-26254C.....	56	YE-2000C.....	33
T-26300C.....	56	YE-2000G.....	34
T-27014C.....	56	YE-3000C.....	33
T-27018C.....	56		
T-27014A.....	56		
T-27018A.....	56		
T-28020.....	55		
T-28200.....	55		

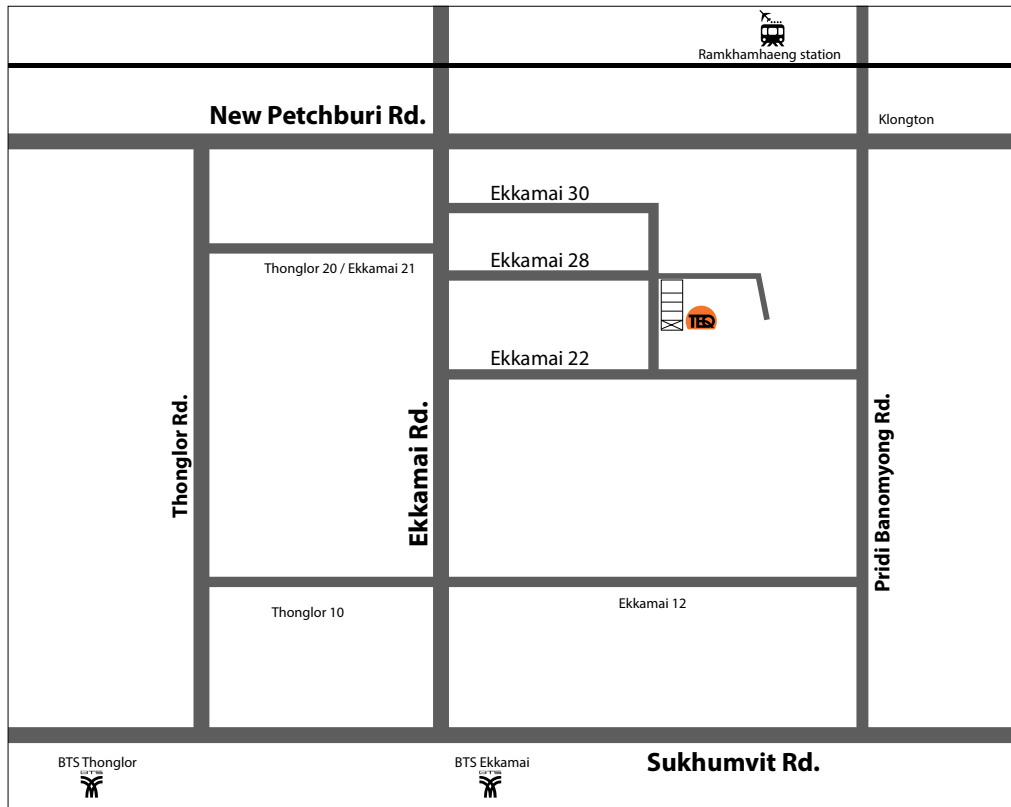

Tec Equipment Limited Partnership

108/1 Soi Nualnoi Sukhumvit Road.
Klongtonnua Wattana District
Bangkok, Thailand. 10110

Tel: +662-392-5272
+662-711-5025
+662-711-5343
Fax: +662-391-5244

email: sales@tecequipment.co.th
www.tecequipment.co.th

หจก.เทคอีควิปเมนท์

108/1 ซอยนวลน้อย ถนนสุขุมวิท แขวงคลองตันเหนือ
เขตวัฒนา กทม 10110

Tel: +662-392-5272
+662-711-5025
+662-711-5343
Fax: +662-391-5244

email: sales@tecequipment.co.th
www.tecequipment.co.th

Conversion Charts

Weight (Mass)

Tonne (Mg)	kg	g	UK Ton	US Ton	cwt	lb	oz
1	1000	10 ⁶	0.9842	1.1011	19.66	2.205 x 10 ³	3.527 x 10 ⁴
10 ³	1	1000	9.842 x 10 ⁻⁴	1.101 x 10 ⁻³	10966 x 10 ⁻²	2.2046	35.274
10 ⁻⁶	10 ⁻³	1	9.842 x 10 ⁻⁷	1.101 x 10 ⁻⁶	1.966 x 10 ⁻⁵	2.204 x 10 ⁻³	3.527 x 10 ⁻²
1.016	1016	1.016 x 10 ⁶	1	1.12	20	2240	35840
0.9081	908.1	9.081 x 10 ⁵	08928	1	17.856	2000	32000
5.085 x 10 ⁻²	50.85	5.085 x 10 ⁴	0.05	0.0560	1	112	1792
4.536 x 10 ⁻⁴	0.4536	453.6	4.46 x 10 ⁻⁴	5 x 10 ⁻⁴	8.92 x 10 ⁻³	1	16
2.835 x 10 ⁻⁵	2.835 x 10 ⁻²	28.349	2.79 x 10 ⁻⁵	3.125 x 10 ⁻⁵	5.580 x 10 ⁻⁴	6.25 x 10 ⁻²	1

Length

km	m	mm	mile	yard	ft	in	10 ⁻³ in
1	1000	10 ⁶	0.6214	1094	3281	3.937 x 10 ⁴	3.937 x 10 ⁷
10 ⁻³	1	1000	6.214 x 10 ⁻⁴	1.0936	3.281	39.370	3.937 x 10 ⁴
10 ⁻⁶	10 ⁻³	1	6.214 x 10 ⁻⁷	1.094 x 10 ⁻³	3.281 x 10 ⁻³	3.937 x 10 ⁻²	39.37
1.6094	1609.4	1.609 x 10 ⁶	1	1760	5280	63360	6.336 x 10 ⁷
9.144 x 10 ⁻⁴	0.9144	914.41	5.682 x 10 ⁻⁴	1	3	36	36000
3.048 x 10 ⁻⁴	0.3048	304.8	1.894 x 10 ⁻⁴	0.3333	1	12	12000
2.54 x 10 ⁻⁵	0.0254	25.4	1.578 x 10 ⁻⁵	2.778 x 10 ⁻²	8.333 x 10 ⁻²	1	1000
2.54 x 10 ⁻⁸	2.54 x 10 ⁻⁵	0.0254	1.578 x 10 ⁻⁸	2.778 x 10 ⁻⁵	8.333 x 10 ⁻⁵	10 ⁻³	1

Area

km2	m2	cm2	mm2	sq. mile	acre	yd2	ft2	in2
1	10 ⁶	10 ¹⁰	10 ¹²	0.38612	247.11	1.196 x 10 ⁶	1.076 x 10 ⁷	1.550 x 10 ⁹
10 ⁻⁶	1	10 ⁴	10 ⁶	3.86 x 10 ⁻⁷	3.86 x 10 ⁻⁴	1.11960	10.764	1550
10 ⁻¹⁰	10 ⁻⁴	1	100	3.86 x 10 ⁻¹¹	3.86 x 10 ⁻⁸	1.196 x 10 ⁻⁴	1.076 x 10 ⁻³	0.1550
10 ⁻¹²	10 ⁻⁶	10 ⁻²	1	3.86 x 10 ⁻¹³	3.86 x 10 ⁻¹⁰	1.196 x 10 ⁻⁶	1.076 x 10 ⁻⁵	1.550 x 10 ⁻³
2.590	2.59 x 10 ⁶	2.59 x 10 ¹⁰	2.59 x 10 ¹²	1	639.96	3.097 x 10 ⁶	1.076 x 10 ⁷	4.01 x 10 ⁸
4.047 x 10 ⁻³	4047	4.047 x 10 ⁷	4.047 x 10 ⁹	1.563 x 10 ⁻³	1	4840	43560	6.273 x 10 ⁶
8.36 x 10 ⁻⁷	0.8361	8.36 x 10 ⁵	8.36 x 10 ⁵	3.228 x 10 ⁻⁷	2.066 x 10 ⁻⁴	1	9	1296
9.29 x 10 ⁻⁸	9.29 x 10 ⁻³	929	92900	3.587 x 10 ⁻⁸	2.296 x 10 ⁻⁵	0.1111	1	144
6.45 x 10 ⁻¹⁰	6.45 x 10 ⁻⁴	6.4516	645.16	2.491 x 10 ⁻¹⁰	1.594 x 10 ⁻⁷	7.716 x 10 ⁻⁴	6.944 x 10 ⁻³	1

Volume

m3	dm3 liter	cm3 (ml)	yd3	ft3	in3	UK gallon	US gallon
1	10 ³	10 ⁶	1.3079	35.311	6102	219.97	264.17
10 ⁻³	1	10 ³	1.308 x 10 ⁻³	3.531 x 10 ⁻²	61.02	0.2200	0.2642
10 ⁻⁶	10 ⁻³	1	1.308 x 10 ⁻⁶	3.531 x 10 ⁻⁵	6.102 x 10 ⁻²	2.199 x 10 ⁻⁴	2.642 x 10 ⁻⁴
0.7646	764.6	7.646 x 10 ⁵	1	27	46650	168.19	201.99
2.832 x 10 ⁻²	28.32	2.832 x 10 ⁴	3.704 x 10 ⁻²	1	1728	6.229	7.481
1.639 x 10 ⁻⁵	1.639 x 10 ⁻²	16.387	2.144 x 10 ⁻⁵	5.787 x 10 ⁻⁴	1	3.605 x 10 ⁻³	4.329 x 10 ⁻³
4.546 x 10 ⁻³	4.546	4.546 x 10 ³	5.946 x 10 ⁻³	0.1605	277.42	1	1.2008
3.785 x 10 ⁻³	3.785	3.785 x 10 ³	4.951 x 10 ⁻³	0.1337	231	0.8327	1

Density

Tonne/m ³ Mg/m ³ g/cm ³	kg/m ³	lb/in ³	UK Ton/yd ³	US Ton/ yd ³	lb/ft ³
1	1000	0.03613	0.75247	0.08428	62.43
10 ⁻³	1	3.613 x 10 ⁻⁵	7.525 x 10 ⁻⁴	8.428 x 10 ⁻⁴	6.243 x 10 ⁻²
27.680	27680	1	20.828	23.328	1.728 x 10 ³
1.3289	1.328 x 10 ³	4.801 x 10 ⁻²	1	1.12	82.955
1.1865	1.1186 x 10 ³	4.287 x 10 ⁻²	0.8928	1	74.074
1.602 x 10 ⁻²	16.019	5.787 x 10 ⁻⁴	1.205 x 10 ⁻²	1.35 x 10 ⁻²	1

Permeability

m/s	cm/s	m/year	Darcy	ft/yr	ft/day
1	100	3.156 x 10 ⁷	1.04 x 10 ⁵	1.035 x 10 ⁸	2.835 x 10 ⁵
0.01	1	3.156 x 10 ⁵	1.04 x 10 ³	1.035 x 10 ⁶	2.834 x 10 ³
3.169 x 10 ⁻⁸	3.169 x 10 ⁻⁶	1	3.28 x 10 ³	3.281	8.982 x 10 ⁻³
9.66 x 10 ⁻⁶	9.66 x 10 ⁻⁴	304	1	1000	2.74
9.658 x 10 ⁻⁹	9.659 x 10 ⁻⁷	0.3048	10 ⁻³	1	2.738 x 10 ⁻³
3.527 x 10 ⁻⁶	3.527 x 10 ⁻⁴	111.33	0.365	365.25	1

Force and Weight

MN	kN	N	kgf	tonf	lbf
1	1000	10 ⁶	1.0196 x 10 ⁵	100.4	2.248 x 10 ⁵
10 ⁻³	1	10 ³	101.96	0.1004	224.82
10 ⁻⁶	10 ⁻³	1	0.10196	1.004 x 10 ⁻⁴	0.2248
9.807 x 10 ⁻⁶	9.807 x 10 ⁻³	9.807	1	9.842 x 10 ⁻⁴	2.2048
9.964 x 10 ⁻³	9.964	9964	1016	1	2240
4.448 x 10 ⁻⁶	4.448 x 10 ⁻³	4.448	0.45455	4.464 x 10 ⁻⁴	1

Pressure, Stress and Modulus of Elasticity

Mn/m ² MPa	kN/m ² kPa	kp kgf/cm ²	bar	atm	m H ₂ O	ft H ₂ O	mm Hg	Ton/ft ²	psi lbf/in ²	lbf/ft ²
1	1000	10.197	10	9.869	102.2	355.2	7500.6	9.320	145.04	20866
0.001	1	1.019 x 10 ⁻²	0.0100	9.87 x 10 ⁻³	0.1022	0.3352	7.5006	0.0093	0.14504	20.886
9.807 x 10 ⁻²	98.07	1	0.9807	0.9678	10.017	32.866	735.56	0.9139	14.223	2048.1
0.100	100	1.0197	1	0.9869	10.215	33.515	750.06	0.9320	14.504	2088.6
0.1013	1.0133	1.0332	1.0132	1	10.351	33.959	760.02	0.9444	14.696	2116.2
9.788 x 10 ⁻³	9.7885	9.983 x 10 ⁻²	9.789 x 10 ⁻²	9.661 x 10 ⁻²	1	3.2808	73.424	9.124 x 10 ⁻²	1.4198	204.45
2.983 x 10 ⁻³	2.935	3.043 x 10 ⁻²	2.984 x 10 ⁻²	2.945 x 10 ⁻²	0.3048	1	22.377	2.781 x 10 ⁻²	0.43275	62.316
1.333 x 10 ⁻⁴	0.1333	1.3595 x 10 ⁻²	1.333 x 10 ⁻³	1.315 x 10 ⁻³	1.362 x 10 ⁻²	4.469 x 10 ⁻²	1	1.243 x 10 ⁻³	1.934 x 10 ⁻²	2.7846
0.1073	107.3	1.0942	1.0730	1.0589	10.960	35.960	804.78	1	15.562	2240
6.895 x 10 ⁻³	6.895	7.031 x 10 ⁻²	6.895 x 10 ⁻²	6.805 x 10 ⁻²	0.7043	2.3108	51.714	6.426 x 10 ⁻²	1	144
4.788 x 10 ⁻⁵	4.788 x 10 ⁻²	4.883 x 10 ⁻⁴	4.788 x 10 ⁻⁴	4.725 x 10 ⁻⁴	4.891 x 10 ⁻³	1.605 x 10 ⁻²	0.3591	4.464 x 10 ⁻⁴	6.944 x 10 ⁻³	1

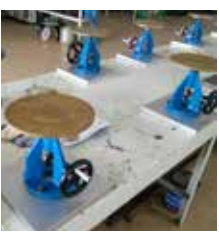

TEQ TEC-EQUIPMENT



TEC-EQUIPMENT

Tec Equipment Limited Partnership

108/1 Soi Nualnoi Sukhumvit Road.

Klongtonnua Wattana District

Bangkok, Thailand. 10110

Tel: +662-392-5272

+662-711-5025

+662-711-5343

Fax: +662-391-5244

email: sales@tecequipment.co.th

www.tecequipment.co.th